

[WWW.SINGERMACHINES.CO.UK](http://WWW.SINGERMACHINES.CO.UK)

# Instructions

*Stylist*

SPECIAL ZIG-ZAG SEWING MACHINE / MODEL 478

**SINGER**

SINGER 478 / 498 SEWING MACHINE MANUAL



*What's new for tomorrow is at **SINGER** today!*

As the owner of the *Stylist*\* Special Zig-Zag Sewing Machine by SINGER, you are about to enter a wonderful new world of sewing! From the moment you begin to sew on your sewing machine, you will be delighted with its easy, dependable operation.

- Perfect straight stitching.
- Practical and decorative zig-zag stitching.
- Twin-needle stitching for those extra finishing touches.
- One-way needle insertion that makes it impossible to insert needle backwards.
- Quick-change throat plate.
- Rapid-action push-button reverse stitching.
- And best of all, easy four-step buttonholing with the built-in buttonholer.

May we recommend that before you begin to sew, you discover all the many advantages of your *Stylist* machine by going through this instruction book step by step while seated at your machine.

SINGER\* service is always close at hand. If your sewing machine should need servicing, call your local SINGER STORE to be sure of warranted SINGER parts and service. You will find the address under THE SINGER COMPANY in the telephone directory.

## CONTENTS

|   |    |
|---|----|
| <b>Getting to Know Your SINGER Sewing Machine</b> ..... | 2  |
| Principal Parts and Accessories .....                   | 2  |
| <b>Threading Your Sewing Machine</b> .....              | 10 |
| The Bobbin Thread .....                                 | 10 |
| The Needle Thread .....                                 | 13 |
| Raising the Bobbin Thread .....                         | 14 |
| <b>Straight Stitching</b> .....                         | 15 |
| Positioning the Needle .....                            | 15 |
| Adjusting for Your Fabric .....                         | 16 |
| Sewing a Seam .....                                     | 22 |
| <b>Zig-Zag Stitching</b> .....                          | 25 |
| Using <i>Fashion*</i> Discs .....                       | 25 |
| Setting Stitch Width and Needle Position .....          | 26 |
| Setting Stitch Length and Needle-Thread Tension .....   | 27 |
| Satin Stitching .....                                   | 28 |
| <b>Twin-Needle Stitching</b> .....                      | 29 |
| Setting the Machine .....                               | 29 |
| Inserting the Twin-Needle .....                         | 30 |
| Threading for Twin-Needle Stitching .....               | 30 |
| <b>Clothes and Home Decorations</b> .....               | 31 |
| Seams .....   | 31 |
| Darts .....   | 40 |
| Hems .....  | 41 |
| Buttons .....   | 42 |
| Buttonholes .....                                       | 43 |
| Zippers .....   | 50 |
| <b>Finishing Touches</b> .....                          | 51 |
| Top Stitching .....                                     | 51 |
| Shell Edging .....                                      | 51 |
| Monograms and Motifs .....                              | 52 |
| Applique .....  | 53 |
| Free-Motion Stitching .....                             | 55 |
| Script Lettering .....                                  | 56 |
| <b>Keeping Up Appearances</b> .....                     | 57 |
| Mending. . . . .  | 57 |
| Blanket Binding .....                                   | 58 |
| Darning .....   | 58 |
| <b>Caring for Your Sewing Machine</b> .....             | 60 |
| Every Few Weeks .....                                   | 60 |
| Removing and Replacing the Bobbin Case .....            | 61 |
| Every Few Months .....                                  | 62 |
| Removing and Replacing the Face Plate .....             | 62 |
| Every Year .....  | 63 |
| Changing the Light Bulb .....                           | 65 |
| Replacing the Slide Plate .....                         | 65 |
| Performance Check List .....                            | 66 |
| <b>Fashion* Aids</b> .....                              | 67 |
| <b>Index</b> .....                                      | 68 |

## PRINCIPAL PARTS

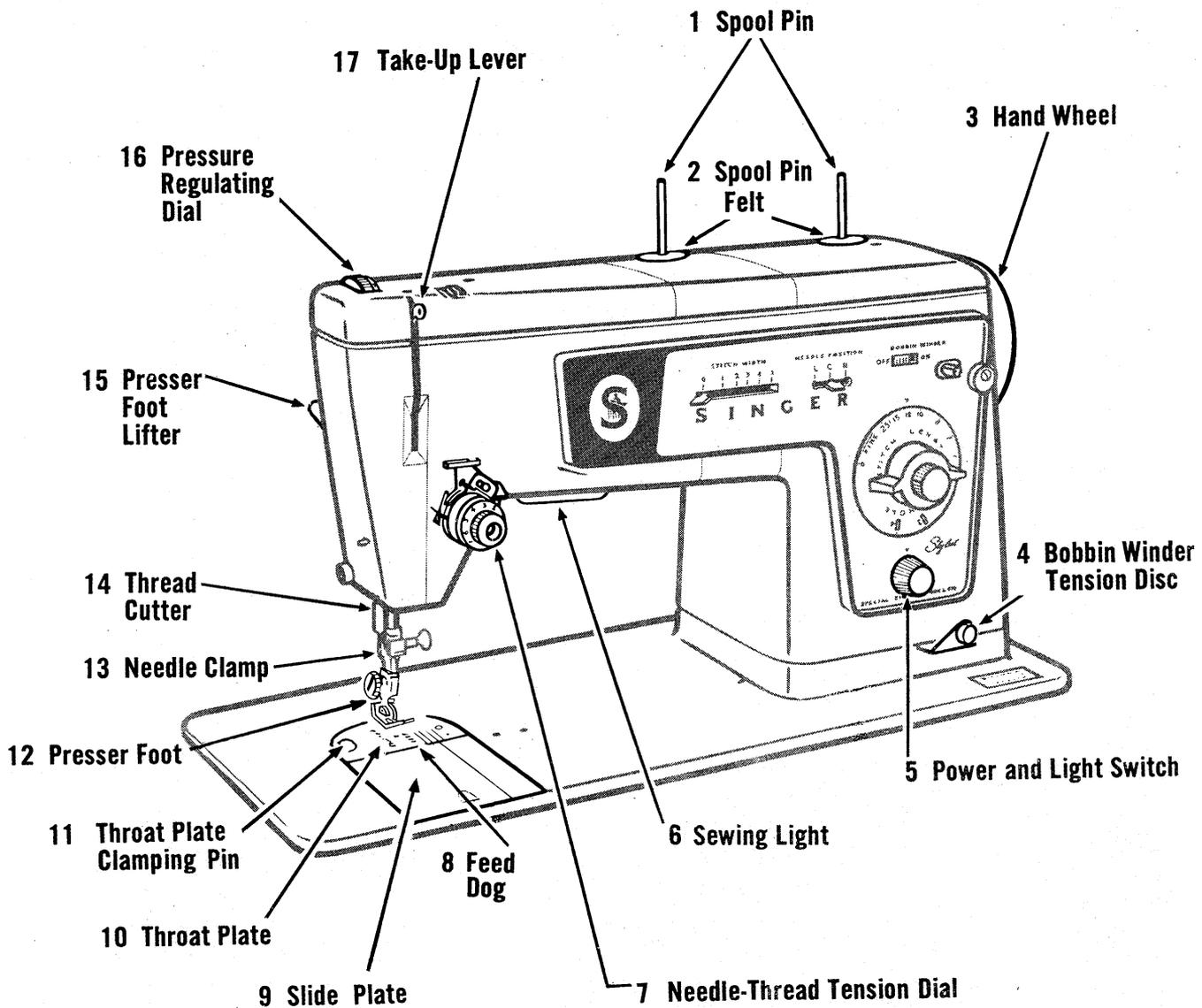

# sewing machine

## ... AND WHAT THEY DO

1. **Spool Pin** — Holds thread spools of various sizes.
2. **Spool Pin Felt** — Helps thread unwind smoothly.
3. **Hand Wheel** — Turns *toward you* to move take-up lever and needle up and down.
4. **Bobbin Winder Tension Disc** — Regulates thread tension for bobbin winding.
5. **Power and Light Switch** — Turns on the power and the sewing light simultaneously. When machine is not in use, the switch should be in OFF position.
6. **Sewing Light** — Concentrates light on sewing area.
7. **Needle-Thread Tension Dial** — Numbers allow for exact, easy-to-duplicate tension settings.
8. **Feed Dog** — Moves fabric as it is being stitched.
9. **Slide Plate** — Opens for easy removal and replacement of bobbin. Locks and unlocks throat plate by raising and lowering the clamping pin.
10. **Throat Plate** — Numbered guidelines help you keep seams straight. To lock in place, close slide plate; to unlock for easy removal, open slide plate fully.
11. **Throat Plate Clamping Pin** — Holds throat plate in place. Actuated by slide plate for easy throat plate removal and replacement.
12. **Presser Foot** — Holds fabric against feed dog.
13. **Needle Clamp** — Holds single and twin needles. It is designed to make needles self-setting and eliminate the possibility of inserting needle backwards.
14. **Thread Cutter** — Cuts thread conveniently and safely.
15. **Presser Foot Lifter** — At back of machine, raises and lowers presser foot and bar.
16. **Pressure Regulating Dial** — Regulates degree of pressure exerted on fabric by presser foot.
17. **Take-Up Lever** — Releases needle thread for forming the stitch and pulls it taut for setting the stitch.

18. **Bobbin Winder Switch and Spindle** — Lets you fill the bobbin with thread quickly and easily. Bobbin stops winding when full.
19. **Needle Position Selector** — Places the needle in either left, center, or right stitching position. Center (C) position is used most often. Left (L) and right (R) settings are for special stitch placement.
20. **Stitch Width Selector** — Settings 1 through 5 allow for a variety of zig-zag stitch widths. 0 setting is for straight stitching.
21. **Stitch Length Selector and Built-In Four-Step Buttonhole Dial** — Has two separate functions. The numbered settings on the stitch length side of the dial allow for a variety of stitch lengths, including FINE for zig-zag satin stitching. The four settings for the buttonhole sequence are on the opposite side of the dial.
22. **Reverse-Stitch Push Button** — Allows you to stitch backwards. It also regulates the density of the stitch for buttonholes made with the built-in four-step buttonholer.

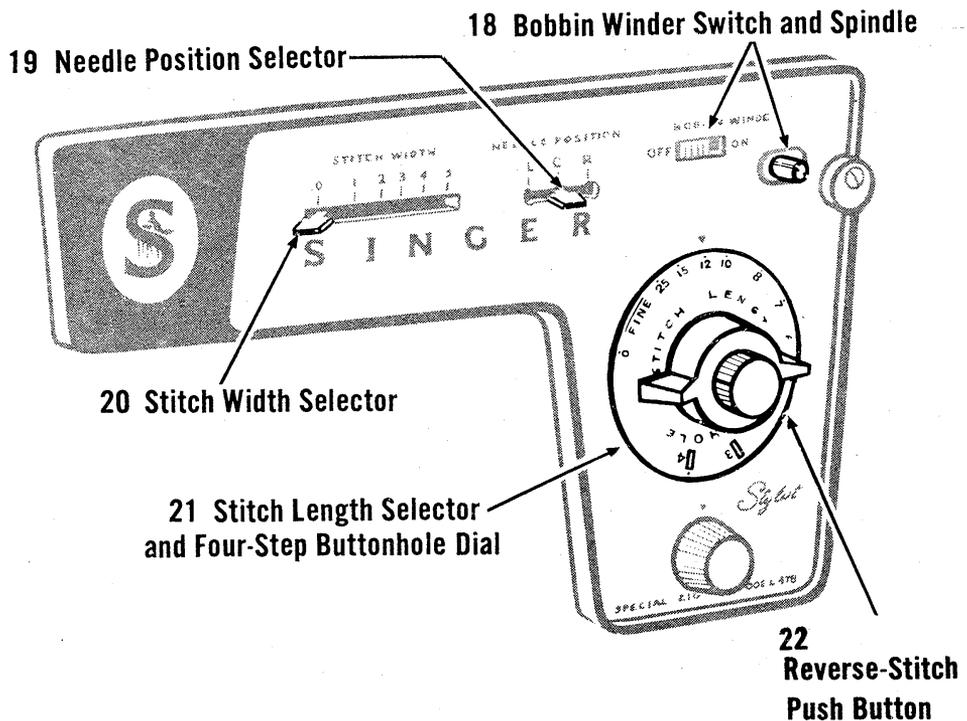

**23. Fashion Disc Holder** — Holds any of the 15 distinctive stitch pattern discs that come with your machine. Disc 1, plain zig-zag, is in place on the holder. *Always keep a disc on the holder, even when you are straight stitching.*

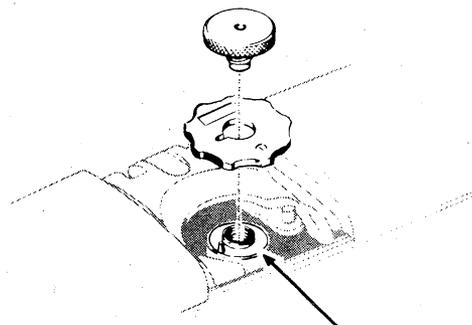

**23 Fashion Disc Holder**

**24. Plug** — Before plugging in the machine, be sure that the voltage and number of cycles stamped on the plate under the hand wheel are within the range marked on the electric meter installed by your power company. To connect the machine, push the machine terminal plug into the receptacle at the right end of the machine. Then connect the wall plug into an electrical outlet.

**24 Machine Terminal Plug**

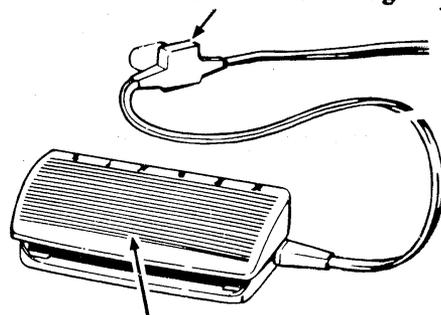

**25 Electrical Speed Controller**

**25. Electrical Speed Controller** — Controls speed of the machine; the harder you press, the faster it will sew.

**26. Transparent Bobbin** — Shows thread supply. It is easily removed for bobbin winding.

**26 Transparent Bobbin**

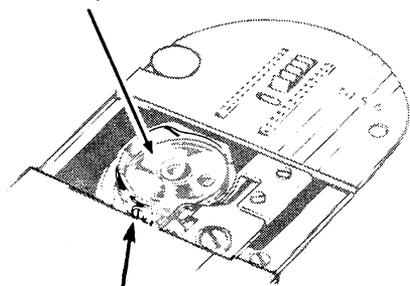

**27 Bobbin-Thread Tension Screw**

**27. Bobbin-Thread Tension Screw** — Seldom needs adjustment. A very slight turn produces a noticeable change in tension.

**28. Stop-Motion Screw** — Directs power to the needle. Loosen the screw for bobbin winding.

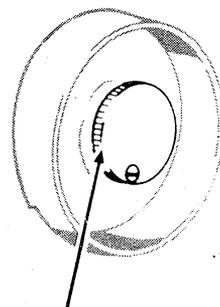

**28 Stop-Motion Screw**

## ACCESSORIES . . . And When To Use Them

The accessories that come with your *Stylist* sewing machine will help you to sew with ease and comfort. They are simple to use and place a variety of sewing effects at your fingertips.

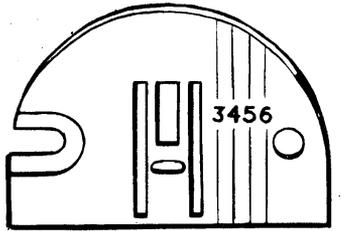

General Purpose Throat Plate

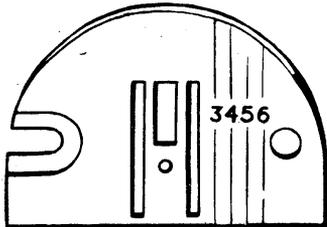
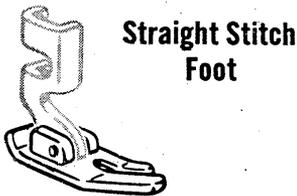

Straight Stitch Throat Plate

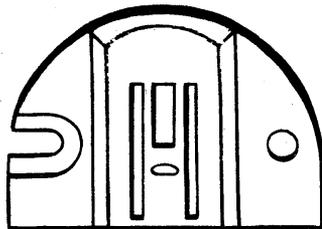

Feed Cover Throat Plate

### General Purpose Foot and Throat Plate

The general purpose foot (snap-on type) and the general purpose throat plate are in place on the machine. Ideal for all utility sewing, these fittings can be used for either straight or zig-zag stitching. *Always use them together* when alternating between straight and zig-zag stitching.

### Straight Stitch Foot and Throat Plate

The straight stitch foot (snap-on type) and the straight stitch throat plate are used with the stitch width selector set at 0 and the needle position selector at C. Use these fittings when fabric or sewing procedure requires close control. Especially useful for:

- Precision stitching of curved and scalloped edges, top stitching, edge stitching, etc.
- Stitching on delicate or spongy fabrics, synthetics, and knits.

### Feed Cover Throat Plate

The feed cover throat plate replaces the general purpose throat plate (or straight stitch throat plate) when fabric feeding is *not* desired. Use it for button sewing (page 42), free-motion darning (page 59), embroidery (page 55) and script lettering (page 56).



### Special Purpose Foot

The special purpose foot is for zig-zag satin stitching. This light, flexible foot has a raised center section that allows closely spaced zig-zag stitches to feed evenly. The small eyelets at the front of the foot hold a filler cord when desired. Use it (with the general purpose throat plate) for:

- Ornamental stitching
- Buttonholes made with selector settings
- Applique

### Buttonhole Foot

The transparent, snap-on buttonhole foot is used to make buttonholes with the built-in four-step buttonholer. The two channels on the underside allow closely spaced zig-zag stitches to feed freely. The guidelines on the sole plate simplify buttonhole placement and make it easy to gauge buttonhole length. For instructions, see page 44.

### Zipper Foot

The zipper foot makes it easy to place stitching close to a raised edge. Thus it is useful for corded seams (page 38) as well as zipper insertion (page 50). It can be adjusted to either the right or the left side of the needle. The foot's hinge allows it to ride over pins, heavy layers of fabric, or across seams.

### Button Foot

This short, open foot holds any two-hole or four-hole button securely for stitching. The groove in the foot can be used to hold a needle, over which a thread shank can be formed. For instructions, see page 42.

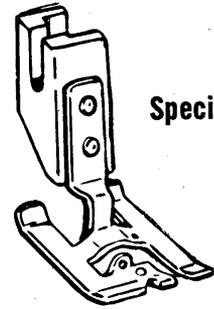

Special Purpose Foot

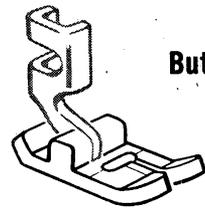

Buttonhole Foot

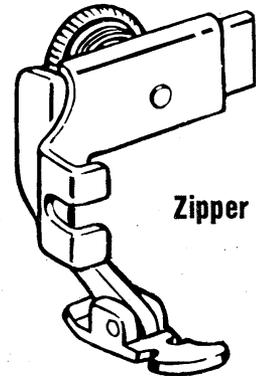

Zipper Foot

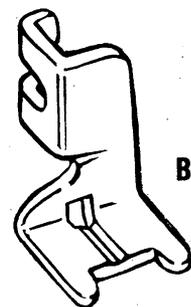

Button Foot

### Changing Presser Feet

The presser feet that come with your machine are of two kinds: snap-on and one-piece. Snap-on feet can be quickly and easily removed and replaced on a single shank. Each of the one-piece feet has its own shank, which attaches to presser bar.

#### Snap-On Presser Foot

The general purpose foot, straight stitch foot, and buttonhole foot snap on and off a common shank.

1. Raise the presser foot and make sure the needle is in its highest position.
2. Press toe of foot upward (as far as it will go) and then snap down to remove.
3. Center the new foot under the shank and hold it in position.
4. Lower the presser bar so that the front opening in the shank fits over the pin in the foot.
5. Press down on the presser foot screw until foot snaps in place.

The shank of the snap-on presser foot is changed in the same way as the one-piece presser foot.

#### One-Piece Presser Feet

The special purpose foot, button foot, and zipper foot have their own shanks and attach to presser bar.

1. Raise the presser foot.
2. Loosen the presser foot screw.
3. Slip presser foot from around the presser bar.
4. Hook new presser foot around bar.
5. Tighten presser foot screw.

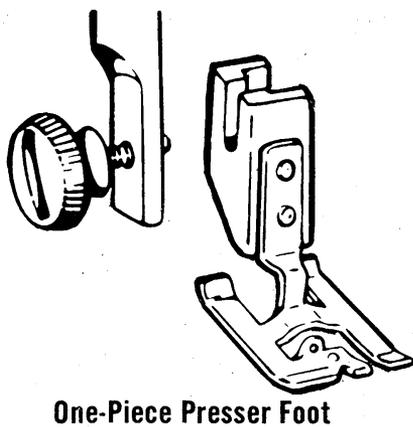
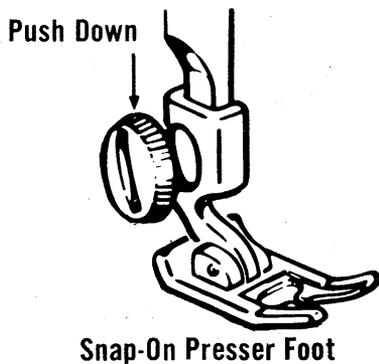
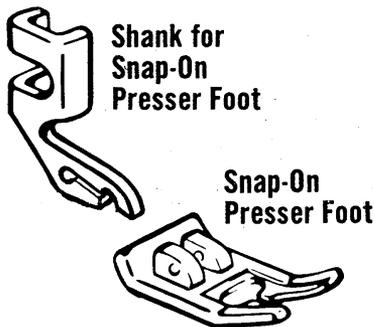

## Changing Throat Plates

- Raise presser foot (you do not need to remove it).
- Turn hand wheel toward you until needle is in its highest position.
- Open slide plate with downward finger pressure. Draw plate toward you, opening it *all the way* to raise the throat plate clamping pin and unlock the throat plate.
- Place thumb under throat plate and draw plate to the right to remove.
- Insert new throat plate under clamping pin and over position pin.
- Close slide plate to lower clamping pin and secure the throat plate.

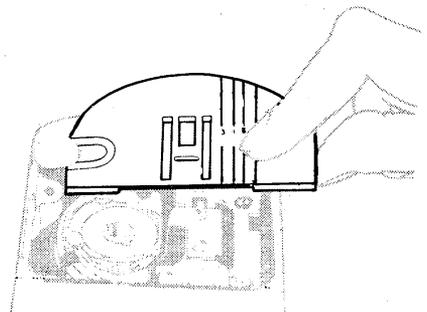
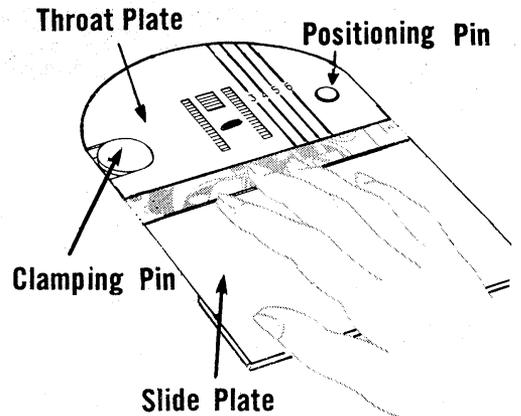

Changing Throat Plate

## Seam Guide

The seam guide helps keep seam width uniform. It is especially useful for unusually wide or very narrow seams and as a guide for top stitching and edge stitching. To attach, place the screw in the hole to the right of the slide plate; line up straight edge of the guide with the throat plate guideline for desired seam width and tighten screw.

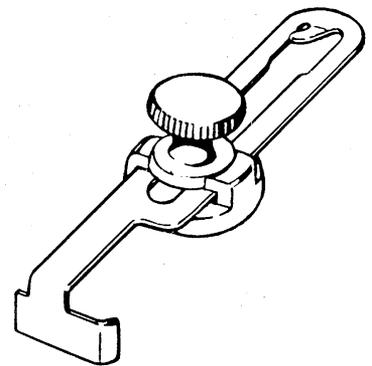

Seam Guide

## Blindstitch Hem Guide

The blindstitch hem guide is used with the general purpose foot to position the hem fold for blindstitch hemming (page 41). To attach, simply loosen presser foot screw and slip guide between screw and presser foot shank. Position guide so that it clears both slide plate and presser foot toe. Tighten screw.

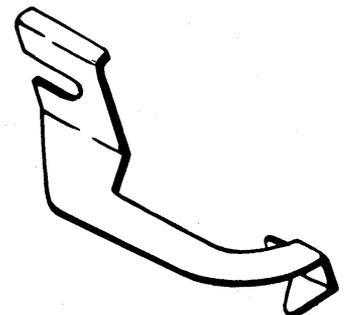

Blindstitch Hem Guide

# Threading your sewing machine

Like all sewing machines that produce what is called a “lockstitch,” your *Stylist* sewing machine sews with two threads. The upper thread comes from the spool and is threaded through the eye of the needle. The lower thread comes from the bobbin, the small plastic spool that you wind using the machine. It is best to wind the bobbin before threading the needle.

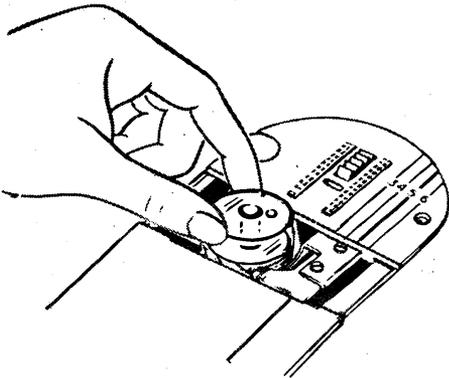

**Removing Bobbin**

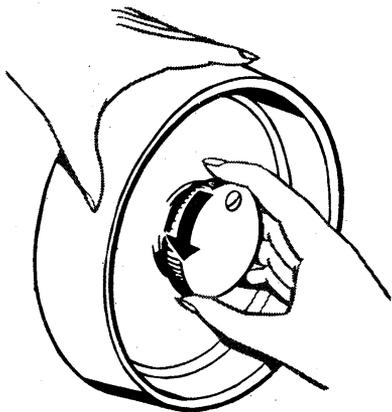

**Loosening Stop-Motion Screw**

## THE BOBBIN THREAD

### Winding the Bobbin

1. Raise the presser foot.
2. Turn hand wheel toward you until needle is in its highest position.
3. Open slide plate. Draw plate toward you, opening it just enough to make bobbin accessible (opening it all the way raises the pin that holds the throat plate in place).
4. Lift out bobbin and close slide plate to make sure throat plate is secure while winding.
5. Loosen the needle stop-motion screw with your right hand while holding the hand wheel with the left.
6. Place bobbin on spindle.

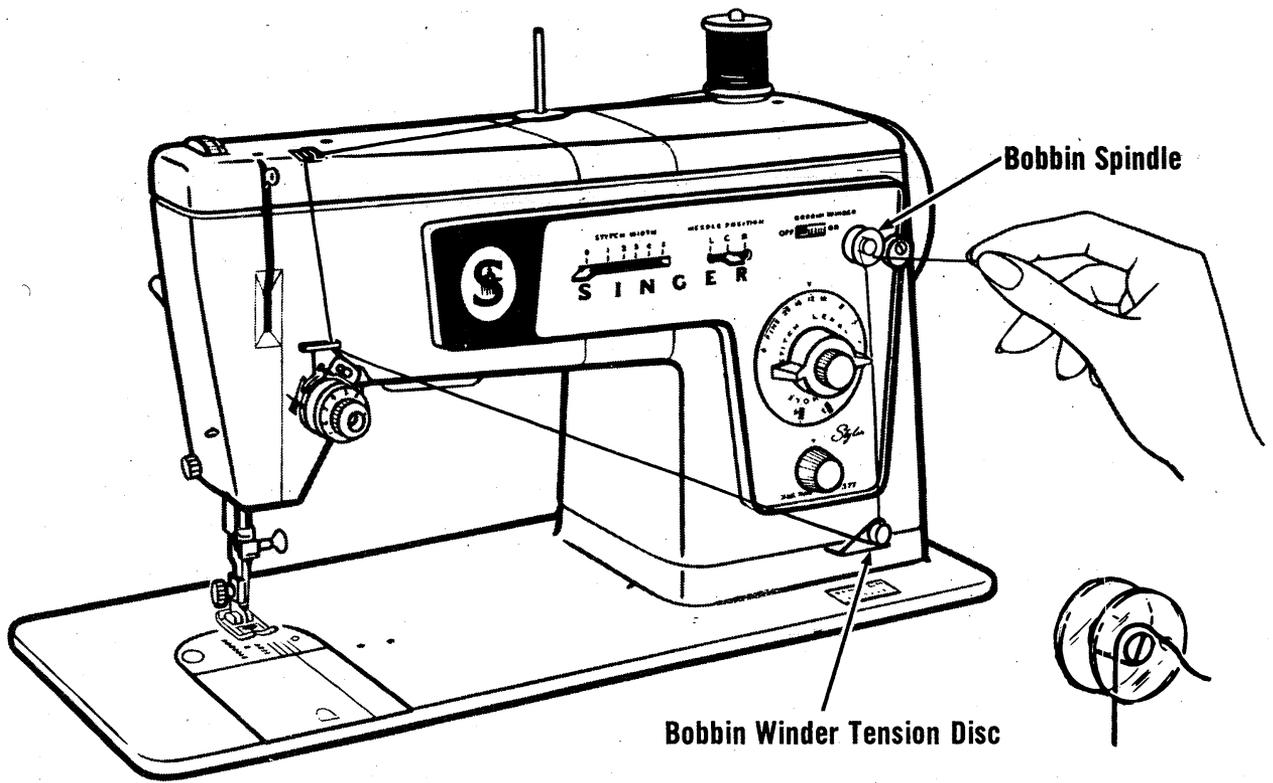

7. Place spool of thread on spool pin over the spool pin felt and lead thread through top cover and tension-assembly thread guides and around bobbin winder tension disc.
8. Pass thread, from the inside, through hole in bobbin.
9. Move bobbin winder switch to ON position, hold thread end as shown, and start the machine.
10. Cut off thread end after a few coils have been wound on the bobbin.
11. When required amount of thread has been wound (winding will stop when bobbin is full), move bobbin winder switch to OFF position, and cut thread.
12. Tighten stop-motion screw by turning it away from you with right hand, while holding the hand wheel with your left hand.

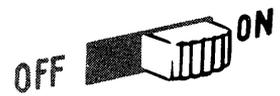

**Bobbin Winder Switch**

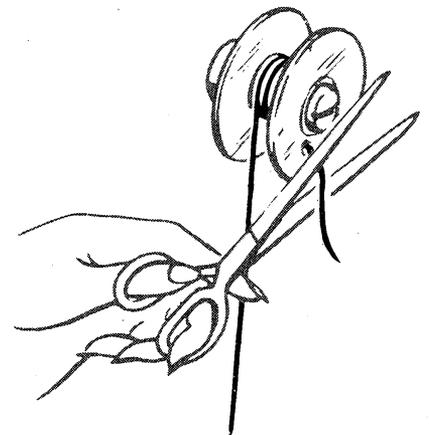

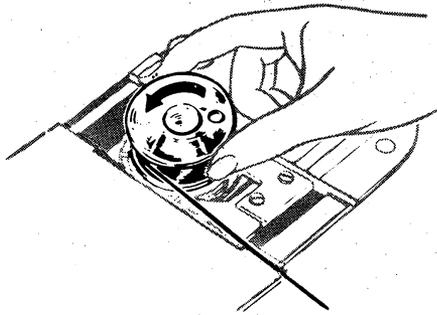

### Threading the Bobbin Case

1. Hold bobbin so that thread unwinds in direction shown, and insert bobbin in bobbin case.

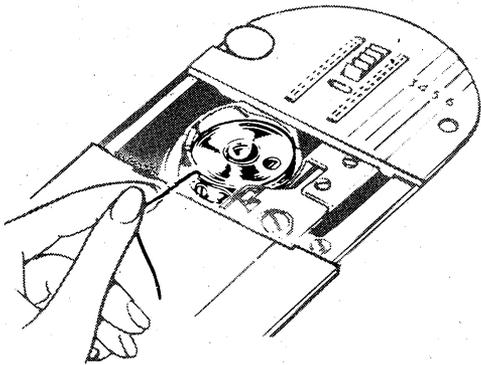

2. Pull thread into notch, draw it under tension spring and back into slot.

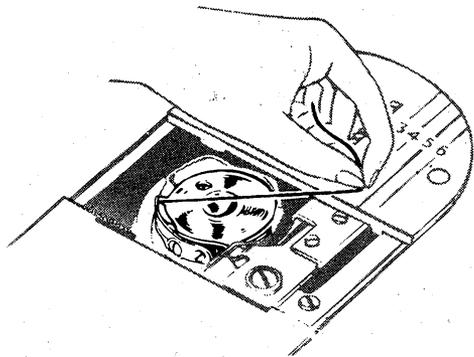

3. Draw about three inches of thread diagonally across the bobbin.

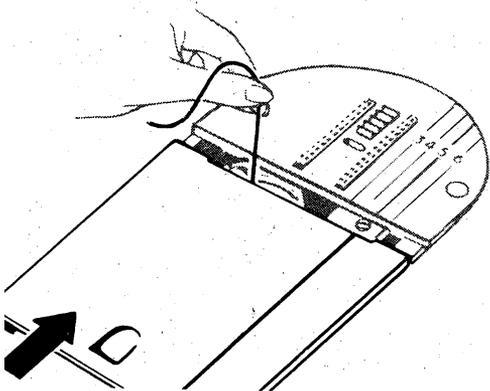

4. Close slide plate with the thread in slot between the throat plate and slide plate.

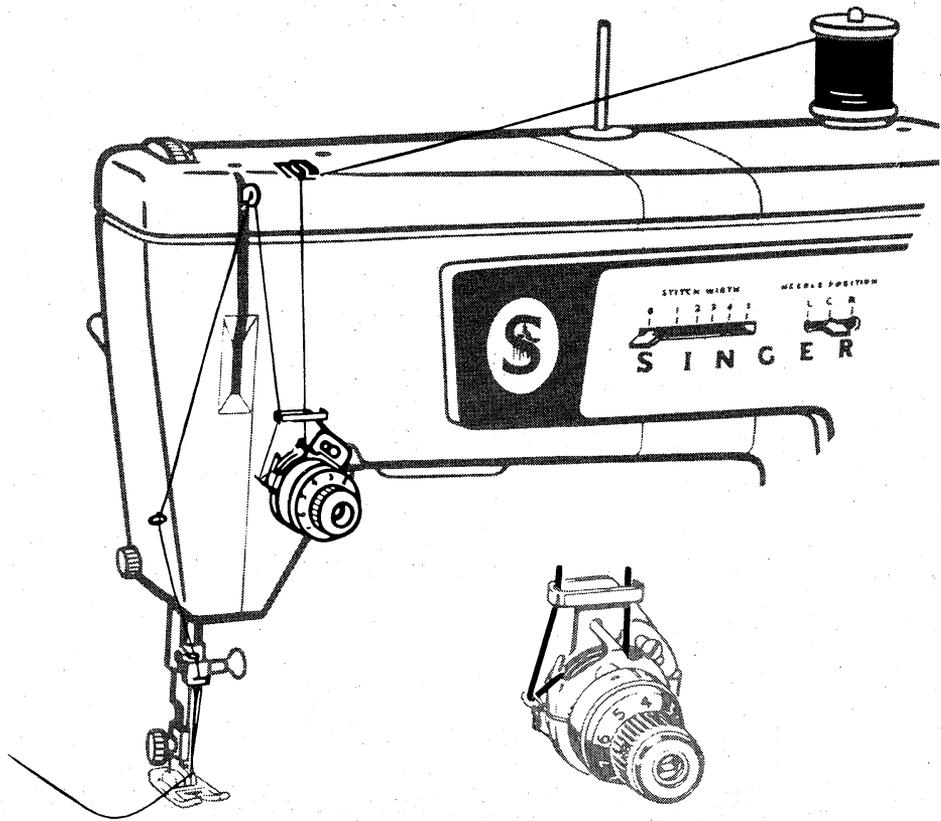

## THE NEEDLE THREAD

1. Turn hand wheel toward you to raise needle to its highest position.
2. Make sure spool pin felt is on spool pin at top of machine.
3. Place spool of thread on spool pin and lead thread through threading points shown. Thread the needle from front to back.
4. Draw about three inches of thread through eye of needle.

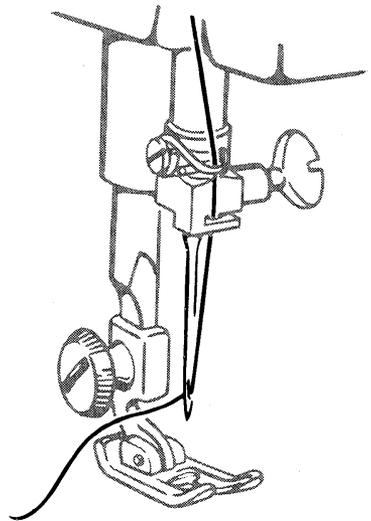

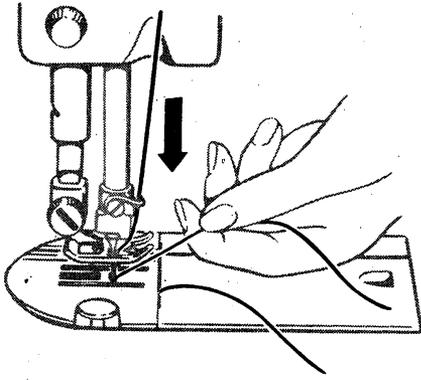

### RAISING THE BOBBIN THREAD

Now that you have wound the bobbin and threaded the needle, you will need to raise the bobbin thread through the needle hole in the throat plate.

1. Hold needle thread lightly with left hand and turn hand wheel slowly toward you so that needle enters hole in throat plate.

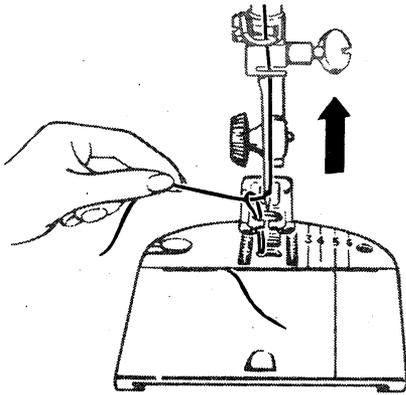

2. Continue turning hand wheel and holding needle thread until needle rises and brings up bobbin thread in a loop.

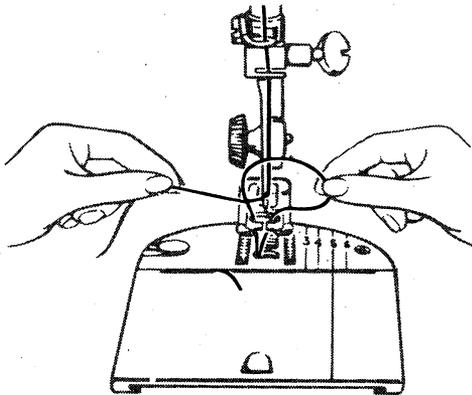

3. Undo the loop with your finger.

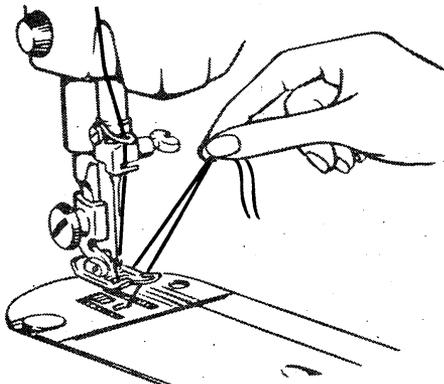

4. Place both needle and bobbin threads under presser foot, and lay them diagonally across the feed dog.

... You are now ready to sew



# Straight stitching

Needle Position: **C**

Stitch Width: **0**

Throat Plate: Straight Stitch or  
General Purpose

Presser Foot: Snap-On Straight Stitch,  
or General Purpose

## POSITIONING THE NEEDLE

Before you set your *Stylist* sewing machine for any kind of stitching, turn the hand wheel toward you until the needle is above the throat plate. Then, to set for straight stitching, simply move the needle position selector to center (C) position and the stitch width selector to 0 position. These settings locate your needle and control its movement so that it stitches straight up and down in the center of the needle hole with no sidewise movement as in zig-zag stitching.

For instructions on setting the stitch width selector and the needle position selector in other positions, see page 26.

## STRAIGHT STITCH ACCESSORIES

Best sewing results will be obtained if you use the straight stitch presser foot and throat plate. However, the general purpose presser foot and throat plate may also be used.

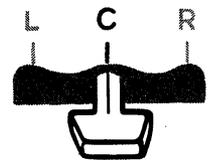

Needle Position

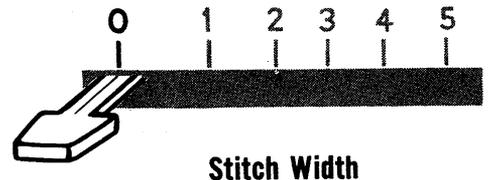

Stitch Width

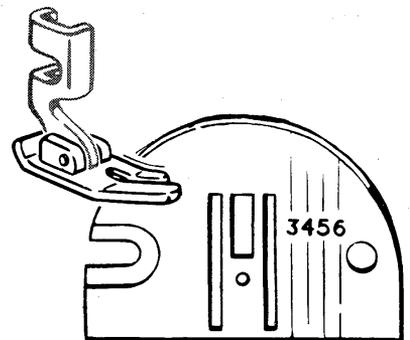

Straight Stitch Accessories



## FABRIC, THREAD, NEEDLE AND STITCH LENGTH TABLE

| FABRICS  | THREAD SIZES  | NEEDLE SIZES | STITCH LENGTH SETTING                |
|--|---|--------------|--------------------------------------|
| <b>DELICATE</b> — tulle, chiffon, fine lace, silk, organdy   | Fine mercerized cotton, fine synthetic thread                   | 9            | 15 to 20                             |
| <b>LIGHTWEIGHT</b> — batiste, organdy, jersey, voile, tafeta, silk, crepe, chiffon velvet, plastic film                              | 50 mercerized cotton, "A" silk, synthetic thread                | 11           | 12 to 15<br>(8 to 10<br>for plastic) |
| <b>MEDIUM WEIGHT</b> — gingham, percale, pique, linen, chintz, faille, satin, fine corduroy, velvet, suitings, stretch fabric, knits | 50 mercerized cotton, "A" silk, synthetic thread, 60 cotton     | 14           | 12 to 15                             |
| <b>MEDIUM HEAVY</b> — gabardine, tweed, sailcloth, denim, coatings, drapery fabrics  | Heavy-duty mercerized cotton, 40 to 60 cotton, synthetic thread | 16           | 10 to 12                             |
| <b>HEAVY</b> — overcoatings, dungaree, upholstery fabrics, canvas  | Heavy-duty mercerized cotton, 24 to 40 cotton                   | 18           | 6 to 10                              |
| <b>ALL WEIGHTS</b> —decorative top stitching   | "D" silk† (buttonhole twist)                                    | 18           | 6 to 12                              |

†Use with 50 mercerized cotton or "A" silk in bobbin.

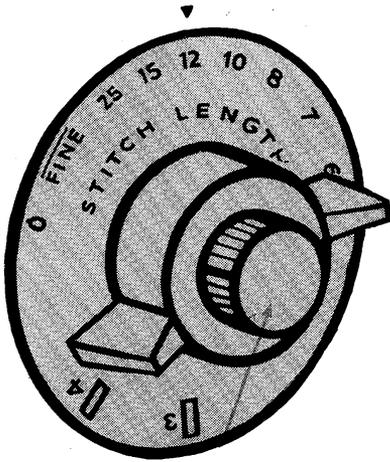

Reverse-Stitch  
Push Button

### Adjusting Stitch Length

The stitch length selector controls the number of stitches per inch. The numbers on the selector represent the number of stitches per inch: the higher the number, the shorter the stitch. Generally, shorter stitches are best for lightweight fabric; longer ones for heavy fabric. The FINE area is used for zig-zag satin stitching only.

- To *shorten* the stitch length, turn the dial clockwise to a higher number.
- To *lengthen* the stitch length, turn the dial counterclockwise to a lower number.

The reverse-stitch push button is located in the center of the stitch length selector. For directions on reverse stitching, see page 22.

## Adjusting Pressure

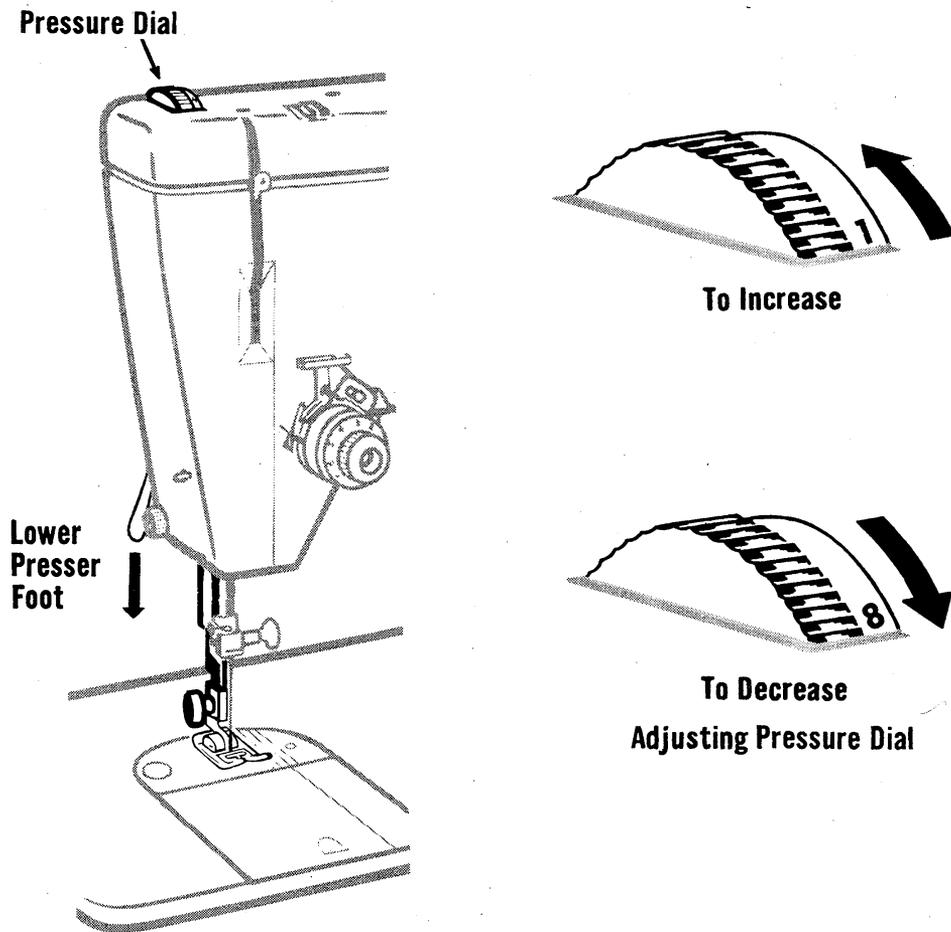

The pressure dial regulates the pressure that the presser foot exerts on the fabric.

Correct pressure is important because it enables the fabric to feed smoothly and evenly, without being marred. The numbered settings on the pressure dial will assist you in obtaining the correct pressure for the fabric you are using. Generally, heavier fabrics require a high number setting (heavier pressure); lightweight fabrics, a lower setting (lighter pressure). But fabric texture must also be considered. Soft fabrics, for example, require less pressure than crisp fabrics. When darning without an embroidery hoop, you should set the dial at the lowest setting, D.

*Lower the presser foot before setting pressure.*

- To *increase* pressure, turn dial to higher number.
- To *decrease* pressure, turn dial to lower number.

### Adjusting Needle-Thread Tension

The tension dial regulates the degree of tension on your needle thread. Set it according to the type of thread and fabric you use. The numbers eliminate guesswork in duplicating settings.

Correct tension is important because too much or too little will weaken your seams or cause your fabric to pucker. Make a test sample with the fabric and thread you plan to use and examine it. A perfect stitch will have the needle and bobbin threads locked between the two layers of fabric with no loops on top or bottom and no puckers.

If stitches look loose, increase needle-thread tension. If the fabric puckers, decrease tension.

- To *increase* tension, turn dial to higher number.
- To *decrease* tension, turn dial to lower number.

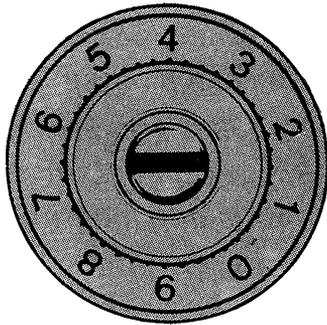

Tension Dial

*(For detailed instructions on adjusting tension for zig-zag satin stitching, see page 28.)*

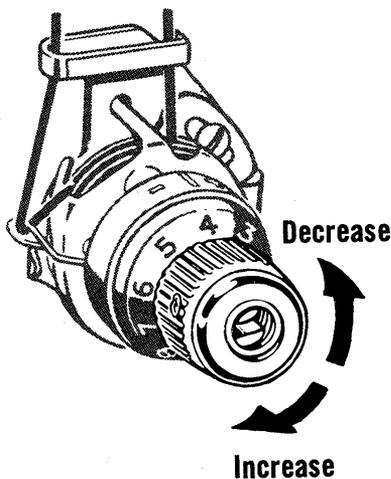

Tension Too Loose



Tension Too Tight



Balanced Tension

## Adjusting Bobbin-Thread Tension

Bobbin-thread tension is controlled by a screw located on the bobbin case. You will seldom need to adjust bobbin-thread tension since it is usually possible to obtain the correct balance by adjusting the needle-thread tension alone.

On those rare occasions when it becomes necessary to adjust the bobbin-thread tension, use the small screwdriver in your accessories box. A very slight turn on the screw nearest the thread slot on the bobbin case will produce a noticeable change in bobbin-thread tension.

- To *increase* tension, turn screw clockwise.
- To *decrease* tension, turn screw counterclockwise.

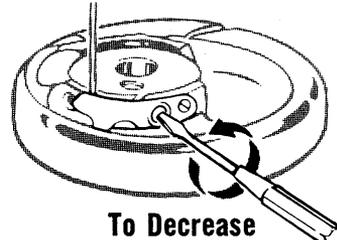
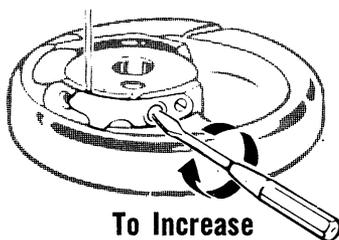

**Balanced Tension**

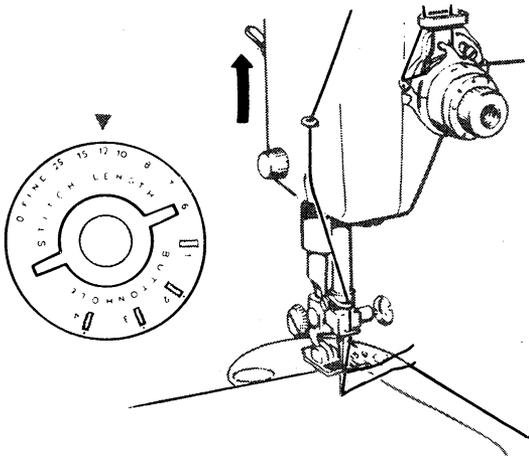

## SEWING A SEAM

### Starting a Seam

1. Set stitch length selector for desired number of stitches per inch.
2. With presser foot up, align fabric with appropriate seam guideline on throat plate (as described on the following page). Position needle in fabric about  $\frac{1}{2}$  inch from the edge.

### Reverse-Stitch Push Button

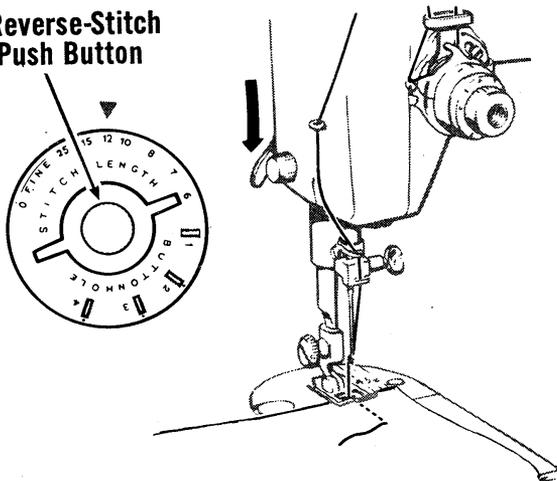

3. Lower presser foot. Backstitch to the edge of the fabric for reinforcement by pushing in the reverse-stitch push button located in the center of the stitch length selector dial. Hold the button until the stitches reach the edge of the fabric and then release.

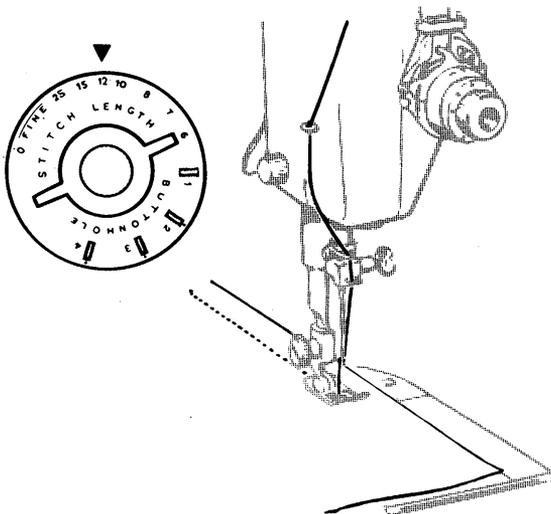

4. Stitch forward.



## Keeping the Seam Straight

As you stitch, use one of the numbered lines on the throat plate as a guide for keeping the seams straight. Numbers indicate distance, in 8ths of an inch, from the needle. If you want a  $\frac{5}{8}$ -inch seam, for example, line up your fabric with line 5. For extra control, use the seam guide (described on page 32).

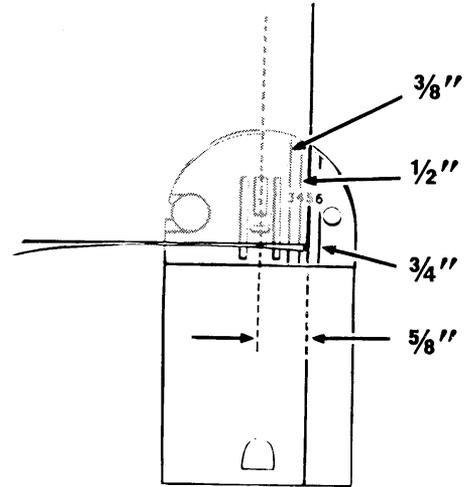

Using Guidelines

## Guiding and Supporting the Fabric

Most fabrics need only to be *guided* in front of the presser foot.

Some fabrics, however, require *support* while being stitched:

- For filmy sheers, knits, etc., apply *gentle* tension by holding seam in front and back of the presser foot.
- For stretch fabrics, apply *firm* tension front and back when stitching in the same direction as the stretch. For seams not on the stretch direction, stitch in conventional manner, guiding fabric in front of presser foot.

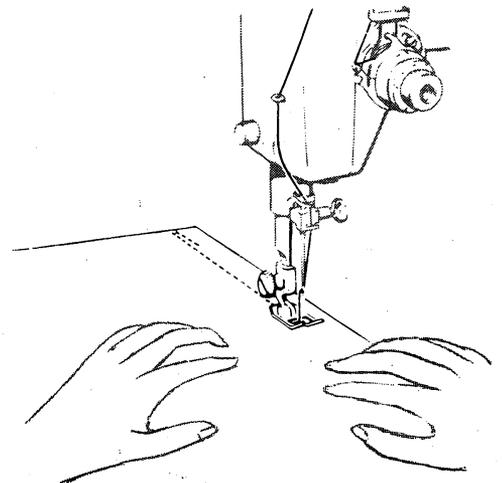

Guiding Fabric

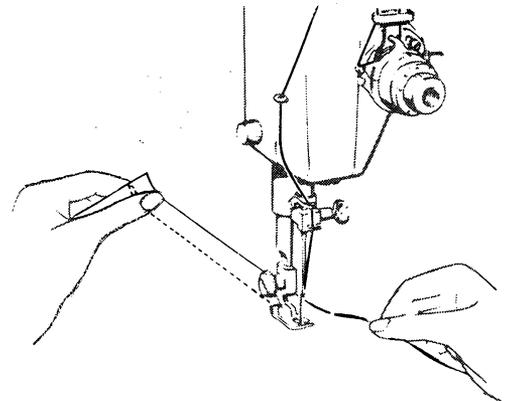

Supporting Fabric

## STRAIGHT STITCHING (continued)

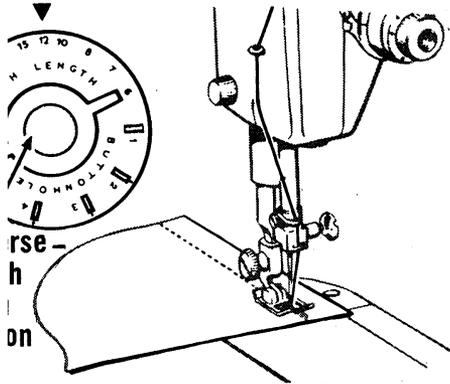

### Ending a Seam

1. Stitch to the fabric edge. Back-stitch  $\frac{1}{2}$  inch to reinforce the end of the seam by pushing in the reverse-stitch push button and then releasing.

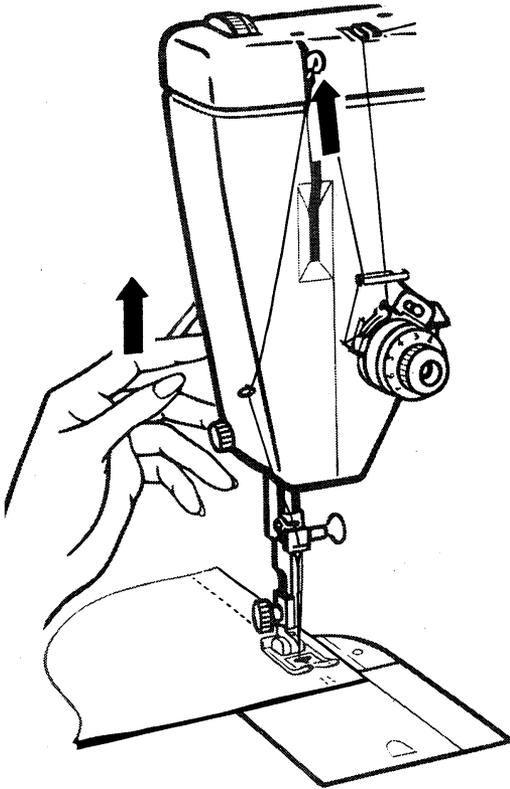

2. Turn hand wheel to bring needle to its highest point.

3. Raise presser foot and remove fabric by drawing it to the back and left.

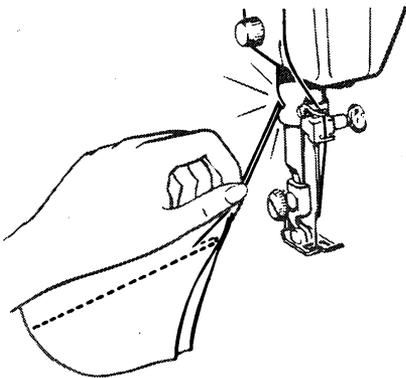

4. Cut threads on thread cutter at rear of presser bar.

# Zig-Zag stitching

Fashion Disc: Desired Pattern  
Needle Position: C  
Stitch Width: 1-5  
Throat Plate: General Purpose  
Presser Foot: General Purpose or  
Special Purpose

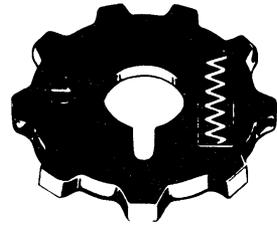

## USING THE FASHION DISCS

The 15 interchangeable *Fashion* discs that come with your machine are zig-zag pattern discs. Each produces an individual design that will add a personal touch to all your sewing. Some discs are purely decorative while others are used for practical purposes as well.

The following interchangeable *Fashion* discs are included with your machine. Disc 1, plain zig-zag, is in place on the *Fashion* disc holder in the machine. (See page 67 for additional *Fashion* discs available for purchase at your Singer store.)



1 Plain Zig-Zag



8 Solid Scallop



19 Ball



2 Multi-Stitch Zig-Zag



9 Icicle



21 Thunderbird



3 Blindstitch

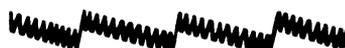

10 Banner



23 Solid Pyramid



5 Arrowhead



12 Walls of Troy



26 Block



6 Domino



13 Diamond



31 Crescent

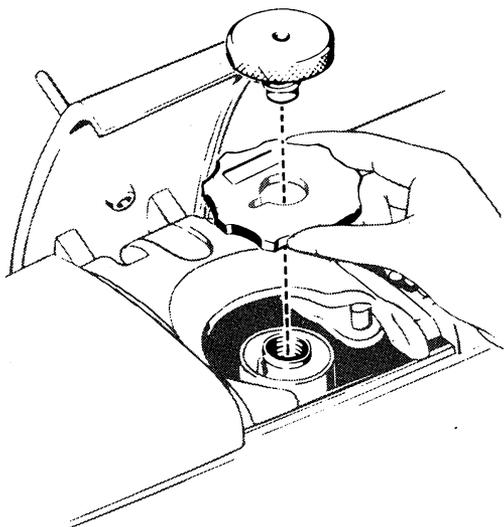

### Removing and Replacing Fashion Discs

1. Position stitch width selector at 0.
2. Raise *Fashion* disc cover and remove the thumb screw.
3. Flip up disc for easy removal.
4. Position new disc on holder and tighten thumb screw securely.

*Always keep a Fashion disc on the holder even when you are straight stitching.*

### SETTING STITCH WIDTH AND NEEDLE POSITION

#### Stitch Width

To produce a zig-zag stitch, the stitch width selector must be moved from its straight stitch position 0, to any setting between 1 and 5. The higher the number you select, the wider your stitch will be.

- To set the stitch width, move the selector to the desired position.

#### Needle Position

Most of your zig-zag stitching will be done in center (C) needle position. Left (L) and right (R) settings are used for special stitch placement, as in buttonholing, button sewing, and twin-needle work.

- To set needle position, move the selector to desired position.

*Be sure to raise the needle above the fabric before changing the stitch width and needle position.*

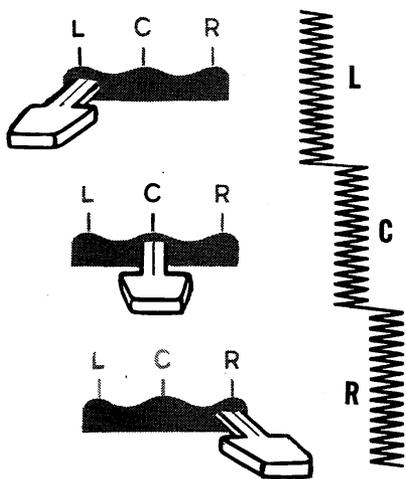
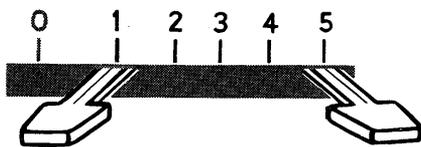

## SELECTING ZIG-ZAG ACCESSORIES

The general purpose throat plate must be used for all zig-zag sewing. The snap-on general purpose presser foot is used for zig-zag stitching of open patterns. The special purpose presser foot is used for decorative satin stitching.

For instructions on changing the presser foot and throat plate, see pages 8 and 9.

## SETTING STITCH LENGTH AND NEEDLE-THREAD TENSION

When you are preparing to do zig-zag stitching, make a test sample on a swatch of your fabric so that you can adjust your stitch length and needle-thread tension properly. If you need to adjust pressure, see page 19.

### Stitch Length

The stitch length you select depends on the kind of sewing you are doing and how you wish your stitches to be spaced. For example, when the blindstitch is used for a hem, the stitch length should be between 12 and 20, depending on the fabric. The lower the number, the more open, or farther apart, your stitches will be.

If you wish your stitches to be closely spaced, a very short stitch or satin stitch is required. This is explained on the next page.

### Needle-Thread Tension

For open zig-zag stitching, you may need to decrease needle-thread tension slightly. Closely spaced stitching requires still less tension.

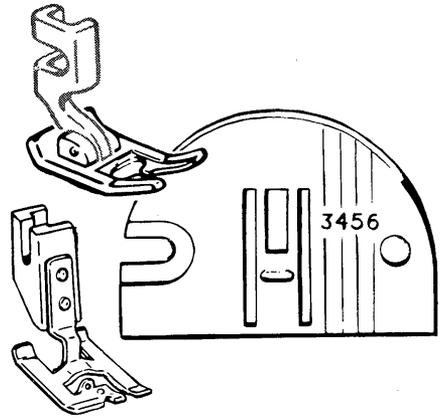

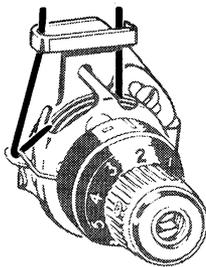
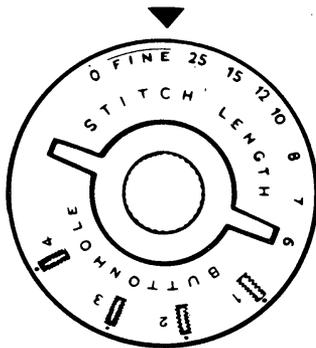
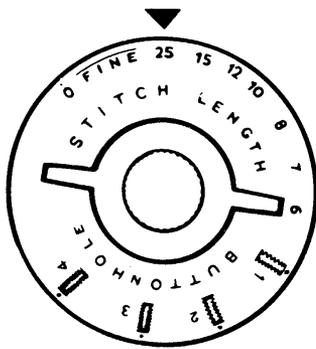

Incorrect



Correct

## SATIN STITCHING

Satin stitching, a series of closely spaced zig-zag stitches, is accomplished by sewing a zig-zag stitch with the stitch length selector in the FINE area. For best results, the special purpose presser foot must be used.

Soft fabrics may require a backing such as crisp organdy or lawn to ensure firm satin stitching.

Needle Position: **C**

Stitch Width: **1-5**

Stitch Length: **FINE (25 or above)**

Throat Plate: General Purpose

Presser Foot: Special Purpose

### Stitch Length

1. Turn stitch length selector dial to 25 (beginning of FINE area).
2. Run the machine at a slow speed.
3. Gradually turn the dial clockwise until stitches are closely spaced and form a smooth surface.

### Tension Adjustment

Satin stitching generally requires less tension than open zig-zag stitching. Furthermore, the wider the satin stitch, the lighter the tension must be. Thus, a stitch width setting of 5 requires the least tension. Make a test sample and lower the tension on your needle thread as required (see page 20).

# Twin-needle stitching

By using a twin needle, you can produce two parallel, closely spaced, decorative lines of stitching simultaneously. You can use either one or two colors of thread, and you can choose either a straight-stitch setting or any of the disc patterns supplied with your machine.

## SETTING THE MACHINE

The general purpose throat plate must be used for all twin-needle sewing. The general purpose presser foot is used for twin-needle straight stitching and zig-zag stitching of open patterns. The special purpose presser foot is used for decorative satin stitching.

### Straight Stitching with a Twin Needle

- Needle Position: **C** or **L** only
- Stitch Width: **0**
- Throat Plate: General Purpose
- Presser Foot: General Purpose

### Zig-Zag Stitching with a Twin Needle

- Fashion Disc: Desired Pattern
- Needle Position: **L** only
- Stitch Width: **1-2½** maximum
- Throat Plate: General Purpose
- Presser Foot: General Purpose (open patterns)  
Special Purpose (satin stitch)

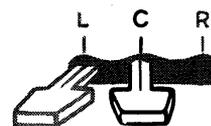
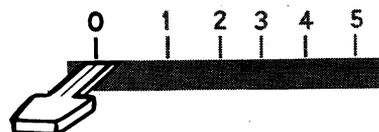
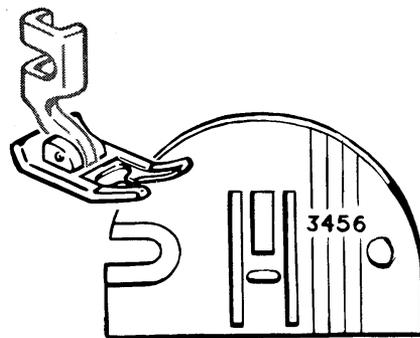

For Straight Stitching

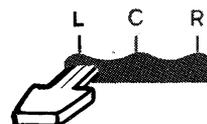
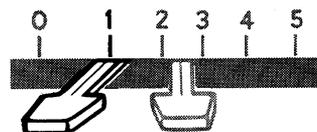
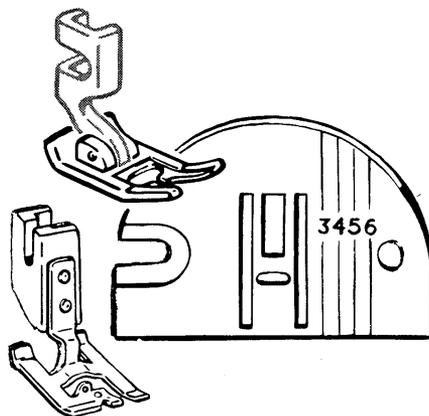

For Zig-Zag Stitching

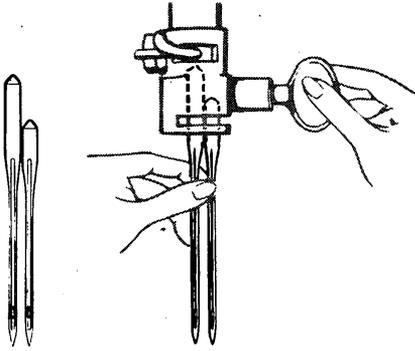

### INSERTING THE TWIN NEEDLE

The needle clamp accommodates the twin needle.

To insert the twin needle, simply loosen the needle clamp screw, remove single needle, and insert the twin needle as instructed on page 16.

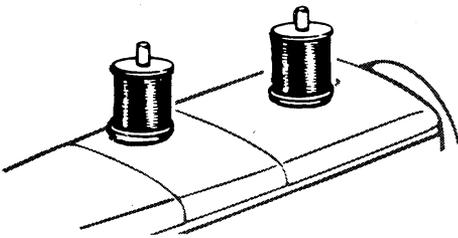

### THREADING FOR TWIN-NEEDLE STITCHING

For best results, use No. 50 mercerized cotton thread.

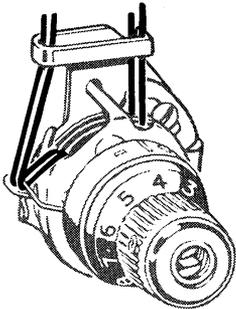

Thread the machine in the same manner as for single-needle stitching except:

1. Be sure that threads are separated by center tension disc as they pass around tension assembly.
2. Carry both threads through the wire loop thread guide above the needle at the same time.
3. Carry only one thread through the last thread guide before the needle.

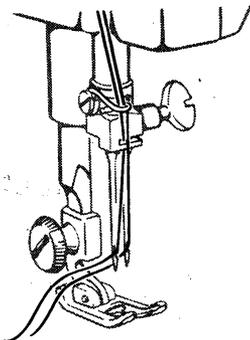



# Clothes and home decorations

## SEAMS

### Pin Basting

Pin basting is a time saver and can be used in place of hand basting when you are straight stitching seams in easy-to-handle fabrics. The straight stitch presser foot is recommended, but the general purpose presser foot may also be used. When sewing over pins with either foot, it is important to use fine pins and to place them correctly in relation to the stitching line.

Place pins so that:

- They are at right angles to the stitching line.
- They just nip into the fabric at the stitching line.
- There is minimum pin extension beyond the stitching line. Pins should not extend under both sides of the presser foot and should never be placed on the underside of the fabric in contact with the feed dog.

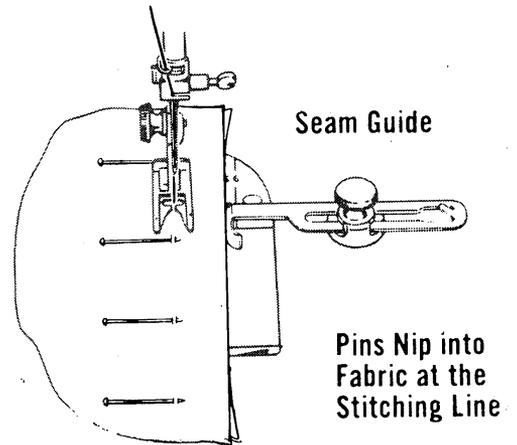

**Pin Placement When Seam Guide Is Used**

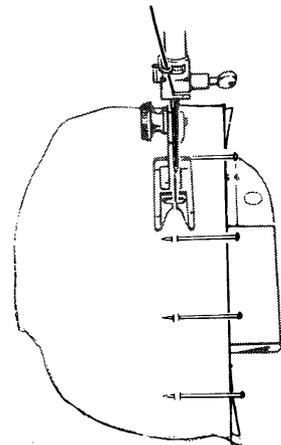

**Pin Placement When Seam Guide Is NOT Used**

## Straight Seams

Needle Position: **C**

Stitch Width: **0**

Stitch Length: **6-20**, depending on fabric

Throat Plate: **Straight Stitch**

Presser Foot: **Straight Stitch**

Seam Guide: (Optional, for extra control)

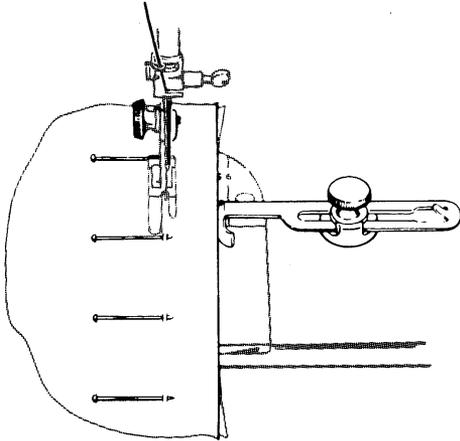

1. Pin seam edges together and baste if necessary. If you pin-baste, place pins as instructed on page 31 so that the hinged presser foot will ride freely over the points.
2. Attach seam guide and align edge with presser foot. Guide the fabric edges lightly against the guide while stitching.

## Straight Seam

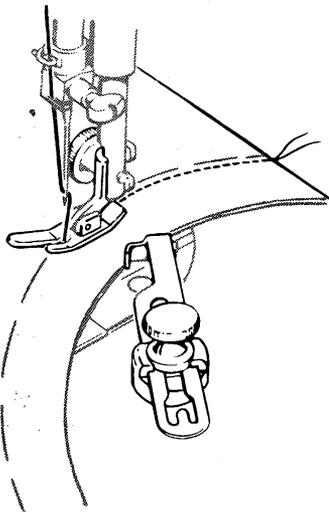

## Curved Seam

## Curved Seams

Follow the same steps as for straight seams *except*:

1. Use a short stitch length for elasticity and strength. For example, if you use 12 stitches per inch for straight seams, select 15 to 20 per inch to stitch curved seams in the same fabric.
2. If you use the seam guide, attach it at an angle so that the edge closer to the needle acts as a guide.

## Lingerie Seams

*Fashion Disc:* 1

*Needle Position:* C

*Stitch Width:* 1½ – 2

*Stitch Length:* 15-20, depending on fabric

*Throat Plate:* General Purpose

*Presser Foot:* General Purpose

To make a lingerie seam both durable and flexible, use a plain zig-zag stitch. This treatment is particularly suitable for bias seams.

1. Straight-stitch the seam (with stitch width at 0) on wrong side.
2. Press both seam allowances in the same direction.
3. From the right side, top-stitch with zig-zag pattern (with stitch width at 1½), letting the needle alternately enter the seam line and seam thickness.

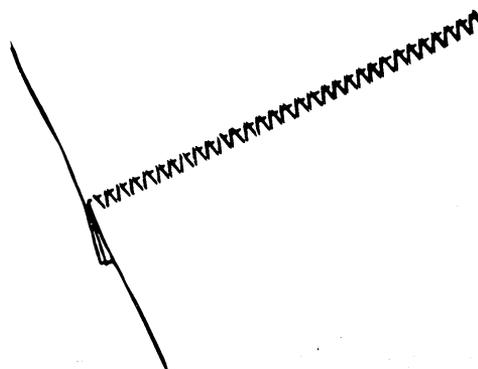

**Lingerie Seam**

## Hairline Seams Inside Sheer Collars, Cuffs, and Facings

*Fashion Disc:* 1  
*Needle Position:* C  
*Stitch Width:* 1  
*Stitch Length:* FINE (25 or above)  
*Throat Plate:* General Purpose  
*Presser Foot:* Special Purpose  
*Pressure:* 2, or 3

With a delicate hairline finish, seam allowances that ordinarily show through can be eliminated. Use a filler cord, such as buttonhole twist or fine pearl cotton, to give body to the seam. Thread the cord through the center eyelet on the special purpose foot. Draw the cord under and in back of the foot.

1. Stitch along seam outline, covering the cord.
2. Trim seam allowance close to line of stitching and press.
3. Turn and press.

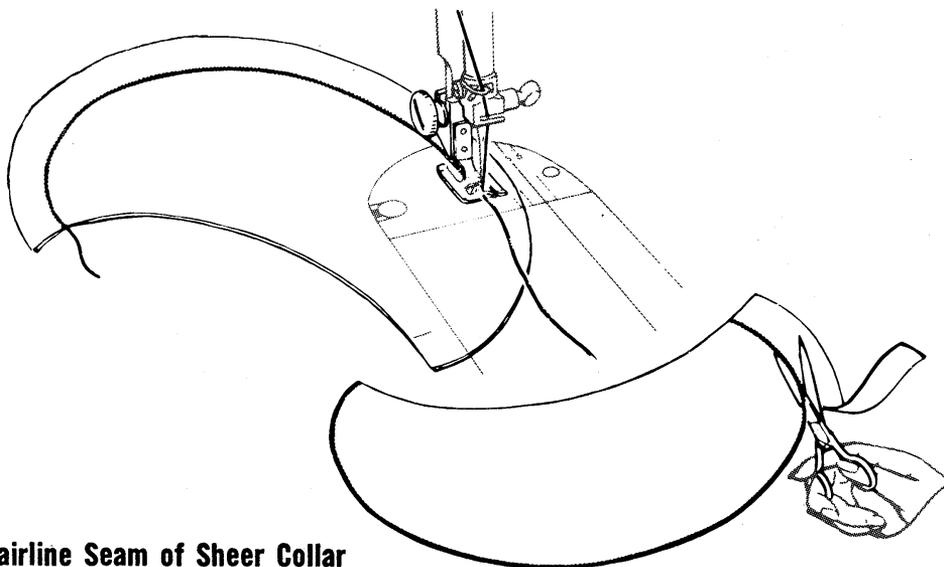

**Hairline Seam of Sheer Collar**

# NEW!

# SINGER\* STRETCH STITCH

Keeping in step with the modern trend in fabrics, SINGER has developed a new stitch specially designed to give you the flexibility required when sewing today's new stretch and knit materials.

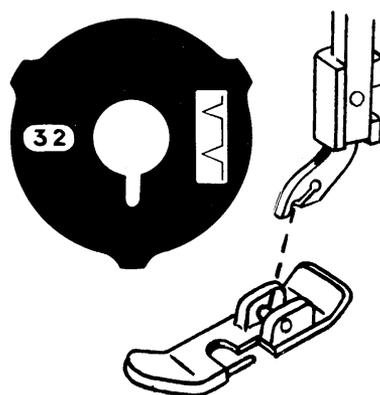

This facility has been made available by adding the overedge foot and stretch stitch disc to your accessories.

## Overedged Seams (Stretch Stitch)

---

*Fashion Disc* : 32 (Stretch Stitch)

Needle Position : C

Stitch Width : 4-5

Stitch Length : About 20

Throat Plate : General Purpose

Presser foot : Overedge

Pressure Dial : 2 or 3

---

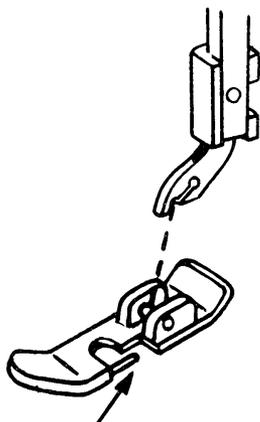

### Thread Guide

The overedged seam is particularly appropriate for use in construction of garments made of knit, stretch or elasticized fabric. When using *Fashion* disc no. 32 with the overedge presser foot, seams that stretch with the fabric can be joined and finished in one operation.

1. Make a test sample first to determine the suitability of an overedged seam in the construction of your garment. Be sure to duplicate the grain of your garment in your test.
2. Adjust stitch length, pressure and thread tension accordingly. Cut and fit garment in the regular way, using a seam allowance of 5/8 inch.
3. Baste fitted seam line.
4. Trim seam edges evenly to 1/4 inch from seam line basting. Place trimmed seam under the presser foot so that the bulk of the work falls to the left and the seam edge to the right *under* the presser foot thread guide (see illustration).
5. Stitch, guiding fabric up to the inside edge of the thread guide so that the straight stitches fall on the seam line and the zig-zag stitches over the seam edge.

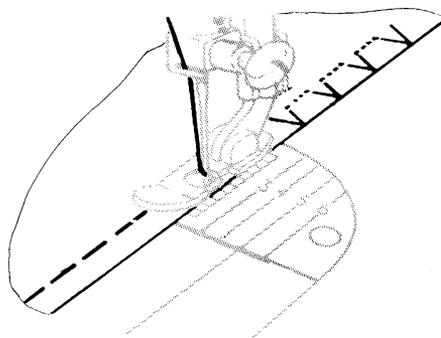
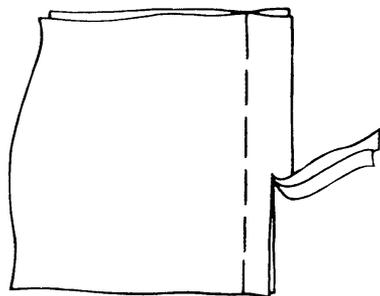

## Seams in Knit Fabrics

*Fashion Disc:* 1

*Needle Position:* C

*Stitch Width:* 2

*Stitch Length:* About 20

*Throat Plate:* General Purpose

*Presser Foot:* General Purpose

A narrow zig-zag stitch is ideal for seaming knit fabrics. It is particularly desirable for underarm seams where elasticity and give are needed.

However, where a stay is needed to prevent undue stretching at neckline and waistline seams, this same stitch can be used to apply seam tape. For a flat, smooth stayed finish :

1. If seam is curved, pre-shape tape to fit by steam pressing.
2. Baste tape in place.
3. Stitch, allowing needle to enter seam tape and seam allowance alternately.

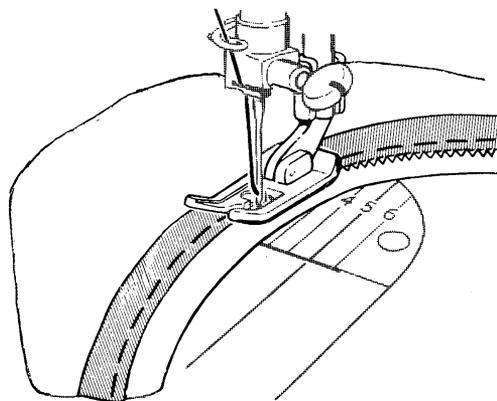

**Curved Seam with Tape Stay**

## Flat-Felled Seams

*Fashion Disc:* 1

*Needle Position:* C

*Stitch Width:* 1½ – 2

*Stitch Length:* 15-20, depending on fabric

*Throat Plate:* General Purpose

*Presser Foot:* General Purpose

Zig-zag stitching gives strength and durability to flat-felled seams.

1. Stitch the seam on the right side of the fabric, taking full seam allowance.
2. Press the seam allowances to one side, keeping the right side of the stitch on top.
3. Trim the under seam allowance to one-half its width.
4. Turn the upper seam allowance edge evenly over the trimmed edge. Top-stitch, letting the needle alternately enter the seam line and the seam thickness.

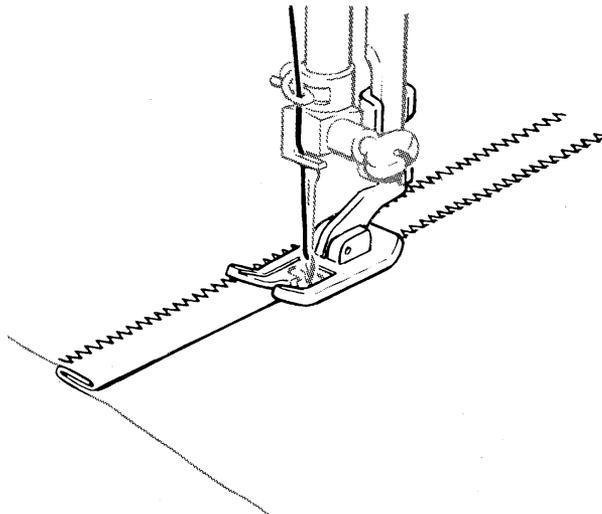

**Flat-Felled Seam**



## Seam Finishes

Fashion Disc: **1, 2, or 3**

Needle Position: **C**

Stitch Width: To suit fabric

Stitch Length: **8-20**, depending on  
choice of stitch and  
fabric

Throat Plate: General Purpose

Presser Foot: General Purpose

Seam edges support the garment and should be given a durable finish if the fabric is likely to ravel.

1. Make a test sample first to determine whether zig-zag stitch 1, multi-stitch zig-zag 2, or blind-stitch 3 best suits your fabric. Also adjust stitch length and stitch width to suit fabric. Choose the settings that will give you the most “open” stitch that will secure the fabric edges; avoid harsh, over-stitched edges.
2. Trim seam edges evenly.
3. Place stitching *near* the edge of the seam allowance or over the raw edge.
4. If the stitching is placed near the edge of the seam allowance, trim off the excess fabric.

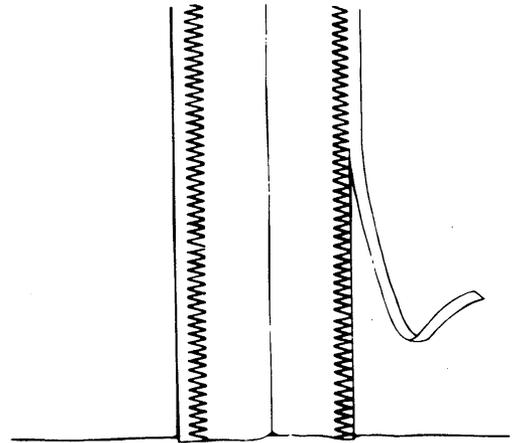

**Trimming  
Seam Edges**

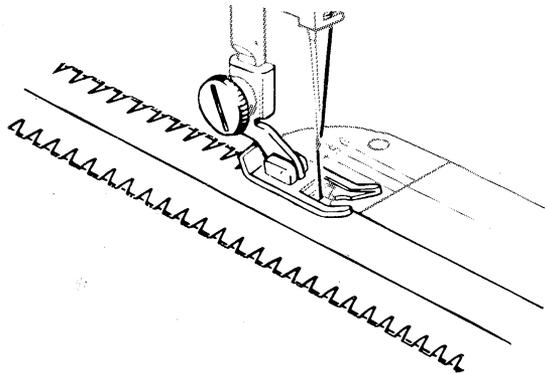

**Overedged Seam Finish**

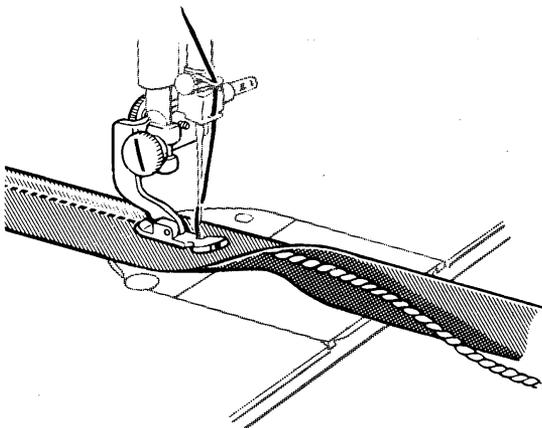
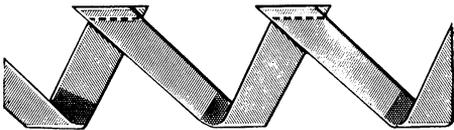
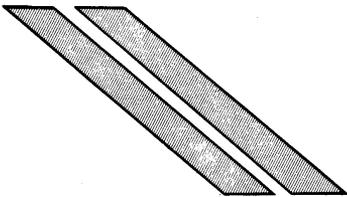
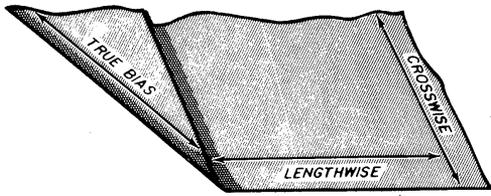

**Making the Welting**

## Corded Seams

Needle Position: **C**

Stitch Width: **0**

Stitch Length: Slightly longer than for regular seaming

Throat Plate: General Purpose or Straight Stitch

Presser Foot: Zipper Foot

The corded seam is a professional treatment for slipcovers, children's clothes, blouses, and lingerie. To make a corded seam, make the welting first (or buy it ready made at a notions counter), then stitch it into the seam. For construction steps, use the above settings and accessories.

### Making the Welting

1. Buy cable cord of the desired size.
2. Cut bias strips of fabric (width: three times the diameter of the cord plus  $1\frac{1}{4}$  inches).
3. Sew strips together on the lengthwise grain to obtain desired length.
4. Fold resulting strip over cord, raw edges even.
5. Adjust zipper foot to the left of the needle. (For instructions on adjusting zipper foot, see page 50.)
6. Lower presser foot.
7. Stitch close to the cord (but do not crowd stitching against cord), pulling gently on the strip, both in front and in back of the zipper foot.

## Stitching Welting into Seams

1. Adjust zipper foot to the right of the needle so that the bulk of the fabric will fall to the left.
2. Stitch welting to the right side of a single seam edge; guide the edge of the foot next to the cord but do not crowd.
3. Place the attached welting over the second seam edge, and pin or baste together.
4. Place the work under the needle, with the first stitching on top so that you can use it as a guide.
5. Stitch, this time crowding the foot against the cord.

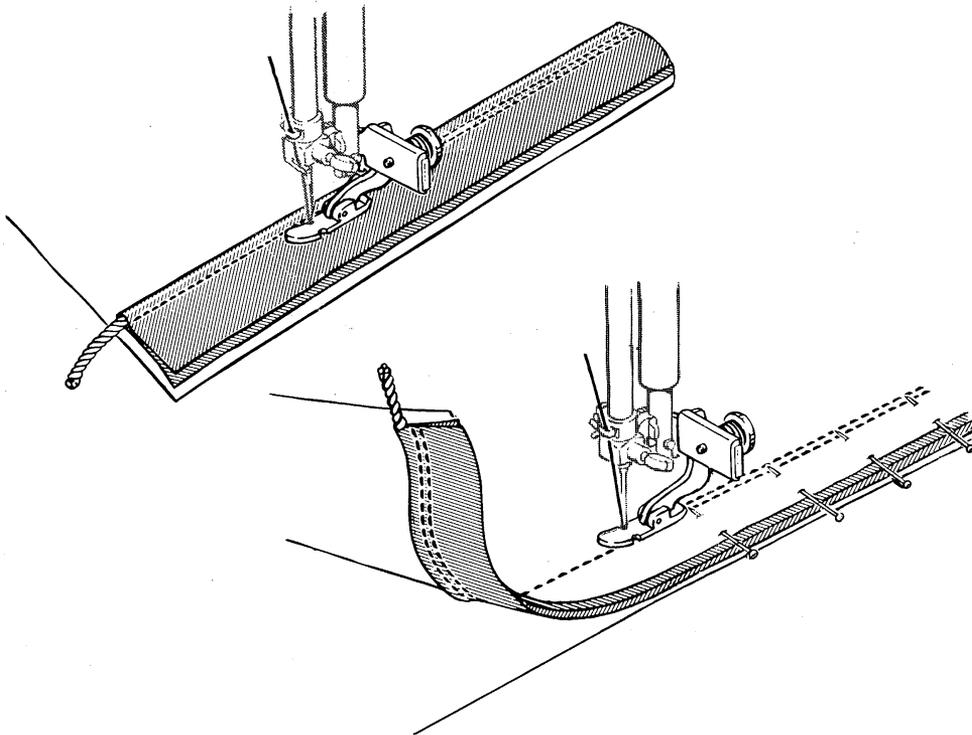

**Making a Corded Seam**

## DARTS

### Regular Darts

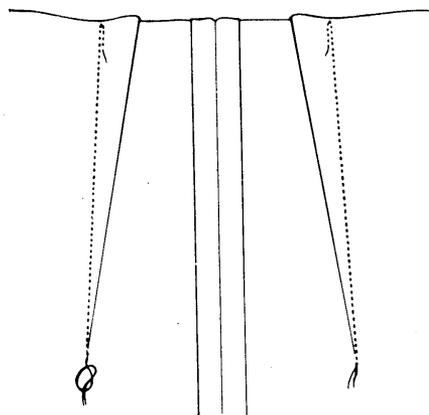

Regular Darts

Needle Position: **C**

Stitch Width: **0**

Stitch Length: About **12** or to suit fabric

Throat Plate: General Purpose

Presser Foot: General Purpose or Straight Stitch

1. Stitch from the seam edge, tapering gradually to the point.
2. Stitch beyond the fabric to form a thread chain  $\frac{1}{2}$  to  $\frac{3}{4}$  inch long.
3. Tie the thread ends into a single knot close to the stitching.

### Darts in Interfacing

With zig-zag stitching, interfacings can be shaped without bulk.

1. Cut out the dart allowance on the stitching line.
2. Bring raw edges together and pin over a muslin stay.
3. Stitch, backstitching at both ends.

Fashion Disc: **1 or 2**

Needle Position: **C**

Stitch Width: **5**

Throat Plate: General Purpose

Presser Foot: General Purpose

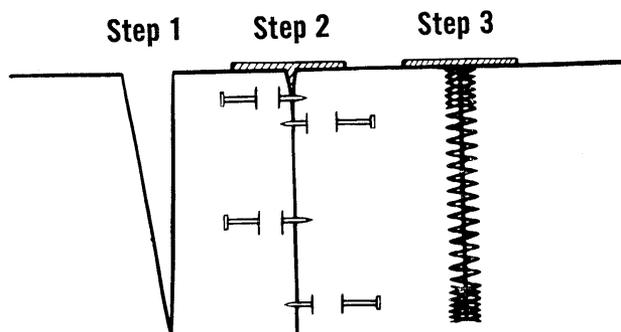

Steps in Making a Dart in Interfacing

## HEMS

### Blindstitch Hems

Blindstitching provides a durable hem finish that can be used on a variety of fabrics. It is best suited to straight hems. Taped, bound, turned, or unfinished hem edges can be blindstitched with equal ease.

1. Mark, turn, and press hem.
2. If it is necessary to baste the hem, place the basting at least  $\frac{1}{2}$  inch from the top edge of the hem so that the basting will not be caught by the flange as you stitch.
3. Attach the blindstitch guide to the presser bar. (For instructions, see page 9.)
4. With the work wrong side up and the bulk of the fabric to the left, turn the hem under, creating a soft fold about  $\frac{1}{4}$  inch from the top edge of the hem.
5. Position the hem under the presser foot with the flange on the front of the guide resting on the  $\frac{1}{4}$ -inch hem edge and the soft fold against the wall of the flange.
6. Stitch so that straight stitches fall on hem edge and sideward stitches pierce the soft fold. While stitching, feed the soft fold against the wall of the flange and guide the hem edge in a straight line.

Fashion Disc: 3  
Needle Position: C  
Stitch Width: 2-4  
Stitch Length: 10-15  
Throat Plate: General Purpose  
Presser Foot: General Purpose  
Blindstitch Hem Guide

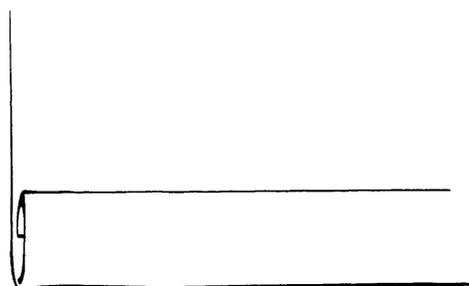

Turn and Press Hem

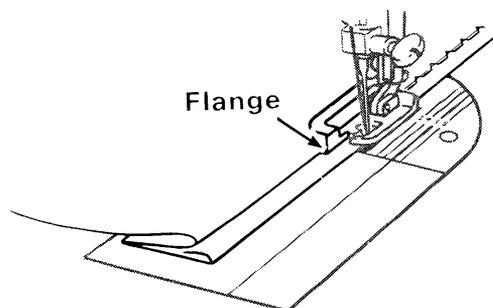

Blindstitch Hem Guide

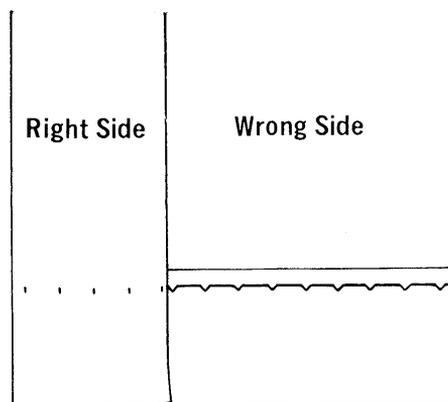

Blindstitch Hem

Fashion Disc: 1  
 Needle Position: L  
 Stitch Width: 0 and 4  
 Throat Plate: Feed Cover Plate  
 Presser Foot: Button Foot

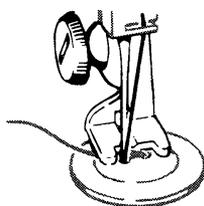
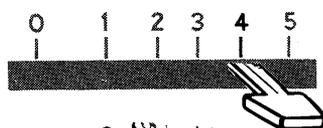
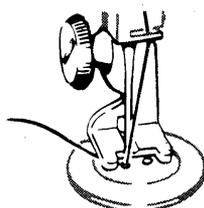

Stitching a Thread Shank

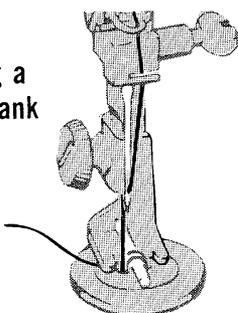

## BUTTONS

The space between the holes in the button determines stitch width settings. The 0 setting must always be used to position the button and fasten stitching at the end. For buttons with standard hole spacing, use settings 0 and 4. For buttons with unusual hole spacing, use setting 0 and increase or decrease the width (4) as necessary.

1. Attach the feed cover plate (see page 9).
2. Set stitch width at 0. Position button under foot and lower needle into center of left hole by turning hand wheel toward you. Lower presser foot. Turn hand wheel toward you until needle rises out of button and is just above the foot.
3. Set stitch width at 4. Then, when you begin to stitch, the needle should enter the right hole of the button. Take six or more zig-zag stitches at this setting. End on left side.
4. To fasten stitching, return to stitch width 0 and take about three stitches.

## Thread Shank

In order to form a thread shank, stitch over the shank of a regular machine needle. Position button and lower button foot. Place needle in groove of the foot so the point enters the hole. Stitch.

Remove the work, leaving two-inch thread ends. Pull the button away from the fabric and pull thread ends through to back of button. Wind the thread ends evenly around the threads between the fabric and button to form the thread shank or stem. Then tie ends securely.

*When work is completed, replace feed cover plate with general purpose (or straight stitch) throat plate.*

## BUTTONHOLES

You can make buttonholes on your *Stylist* sewing machine by two methods. By using the built-in buttonholer, you can make buttonholes of identical widths but of varying lengths, on medium-weight fabrics. You simply turn the buttonhole dial four times to produce accurate buttonholes quickly and easily. To make buttonholes of varying widths, you can set the selectors yourself. Detailed instructions are given for making both of these buttonholes; however, you will find the following information basic to both.

### Buttonhole Position

Accurate guidelines are essential to keep buttonholes a uniform distance from the faced edge of the garment, evenly spaced, and on the grain of the fabric.

Be sure the center line of the garment is marked with hand basting that follows the lengthwise grain of the fabric.

With hand basting, mark a position guideline for each buttonhole; then mark the ends.

*Horizontal* buttonholes are placed to extend  $\frac{1}{8}$  inch beyond the center line basting of the garment. Horizontal guidelines for the buttonholes should follow the crosswise grain of the fabric and be longer than the finished length of the buttonhole. Determine the length of the buttonhole as described below and mark the ends.

*Vertical* buttonholes are placed so that the center line basting of

the garment is in the center of the buttonholes. Mark the ends of each buttonhole with basting horizontally across the center line and use the center line basting as a buttonhole guide when stitching.

### Buttonhole Length

How long the opening needs to be depends on the diameter and thickness of the button. To find the right length:

1. Cut a small hole in a scrap of your fabric and gradually enlarge it until the button slips through.
2. Add a scant  $\frac{1}{8}$  inch ( $\frac{1}{16}$  inch for each bar tack, the closing at each end of the buttonhole), and mark the fabric as shown.

This bar-tack measurement is approximate; on buttonholes made with selector settings, you may need to increase it to arrive at pleasing proportions.

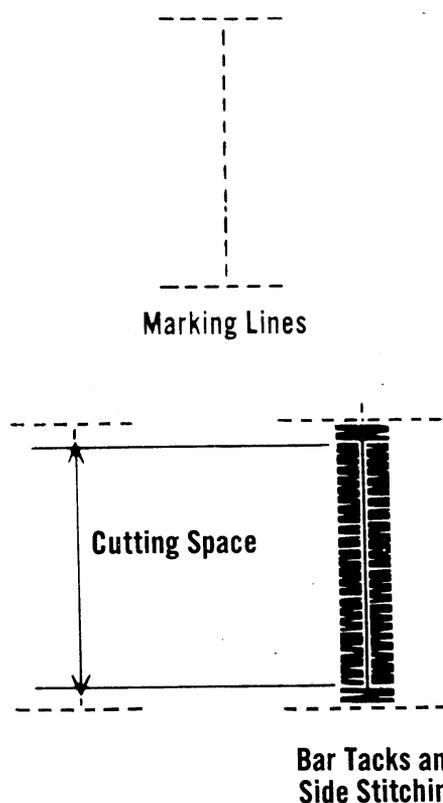

## BUTTONHOLES (continued)

Fashion Disc: 1

Throat Plate: General Purpose

Presser Foot: Snap-on Buttonhole Foot

Stitch-Density Line: Neutral (page 46)

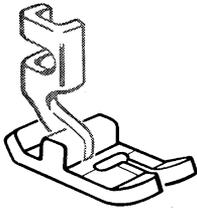

Buttonhole Foot

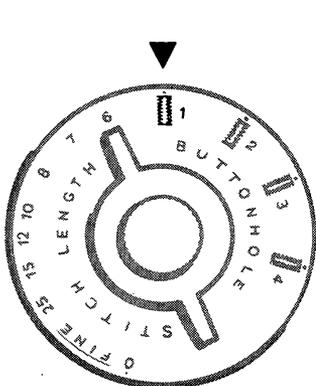
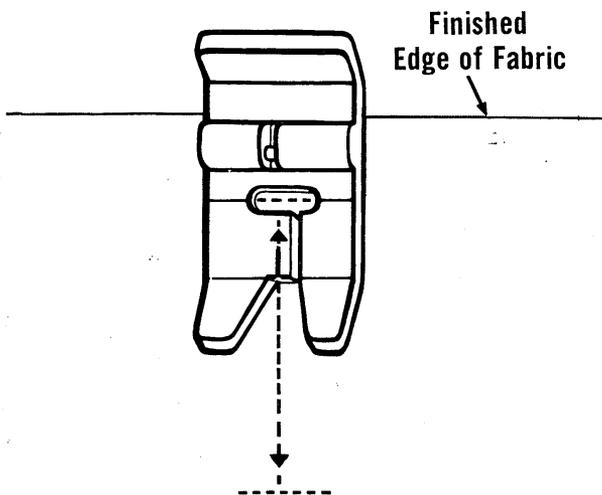

### Buttonholes Made with the Built-In Four-Step Buttonholer

The four dial settings for buttonholing are located on the opposite side of the stitch length selector. As you turn the dial for each step, your machine is automatically set for the correct needle position, stitch width, and stitch length as well as for stitching direction for that step. You need not turn the fabric during buttonholing.

Always make a test buttonhole on a sample of your fabric. Be sure to duplicate the thickness of the garment and include interfacing if appropriate. If the two lines of stitching in your sample are of unequal density, see page 46.

*Raise the needle above the fabric before turning the buttonhole dial.*

#### Procedure

Place the work under the buttonhole foot; align center marking of buttonhole with center *score line* on the foot, and align the end marking of buttonhole with the horizontal *score lines* on the foot. Do not lower the needle.

#### Step 1: Side Stitching

Turn the buttonhole dial *clockwise* to step 1 (aligning it with the arrow above the dial). Position needle in fabric at point A. Lower the foot and stitch to the end of the buttonhole (point B). The end marking should be aligned with the horizontal *score lines* on the foot.



### Step 2: Bar Tack

Raise the needle above the fabric by turning the hand wheel toward you.

Turn the buttonhole dial *counterclockwise* to step 2. Take four or five stitches (point C).

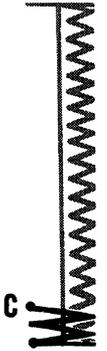
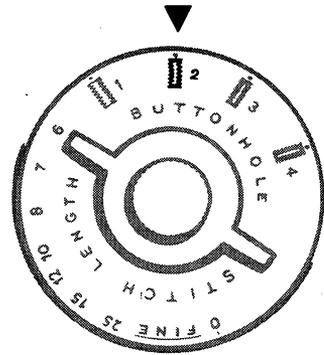

### Step 3: Side Stitching

Raise the needle above the fabric.

Turn buttonhole dial *counterclockwise* to step 3. Stitch to within two stitches of the end of the buttonhole (point D).

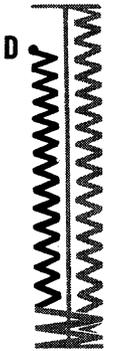
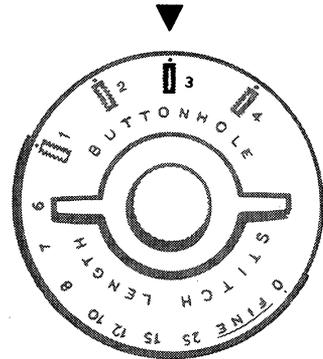

### Step 4: Bar Tack

Raise the needle above the fabric.

Turn buttonhole dial *counterclockwise* to step 4. Take four or five stitches (point E).

Remove the work, draw threads to the underside, tie, and trim.

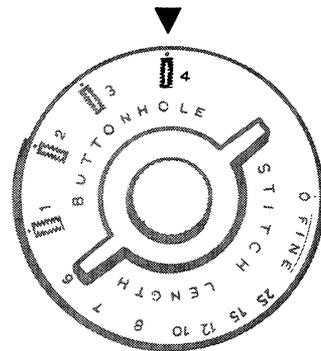



Incorrect



Correct

### Balancing the Two Lines of Stitching

On different kinds of fabric, there may be a difference in the density of the stitches on the right and left sides of the buttonhole. This is easily adjusted by turning the push button to balance the stitching. A very slight turn will produce a noticeable change.

- Begin with the stitch-density balance line in a neutral position.
- Turn the push button to the *left* to increase the density of the stitches on the *left* and decrease on the right.
- Turn the push button to the *right* to increase the density of the stitches on the *right* and decrease on the left.

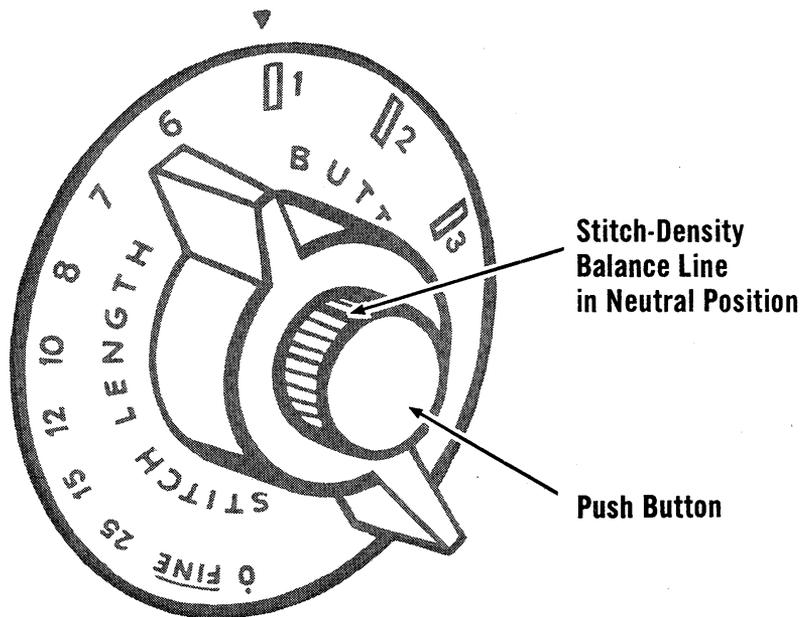

## Buttonholes Made with Selector Settings

Fashion Disc: 1  
Needle Position: L  
Stitch Width: (see below)  
Stitch Length: FINE (25 or above)  
Throat Plate: General Purpose  
Presser Foot: Special Purpose

Always make a test buttonhole on a sample of your fabric. Be sure to duplicate the thickness of the garment and include interfacing if appropriate.

*Be sure to set the needle position selector in left (L) needle position.*

### Stitch Width

You will use two stitch width settings: one for the side stitching and one for the bar tacks. Three possible combinations are illustrated.

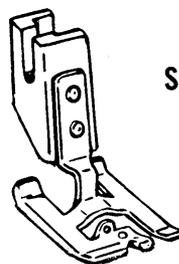

Special Purpose Foot

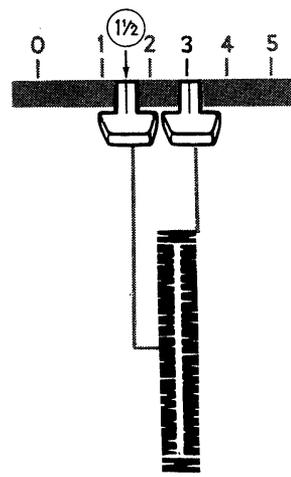
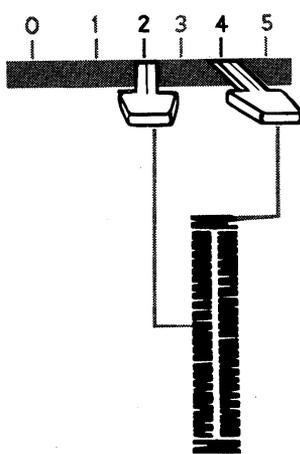
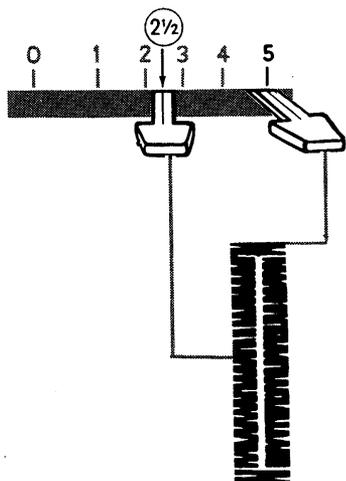
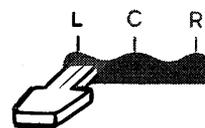

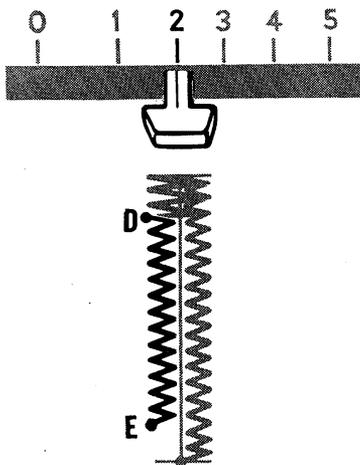
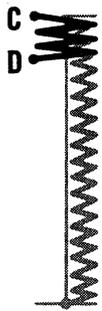
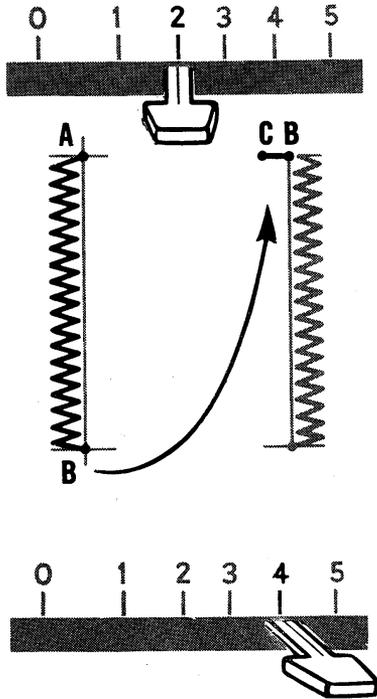

**Procedure**

Set needle position selector at L and stitch width selector for the desired width for side stitching. Place work under needle, aligning center marking of buttonhole with the notch in the special purpose foot.

**Side Stitching**

Position needle in fabric at point A. Lower foot and stitch to end of marking. Leave needle in fabric at point B. Raise foot and pivot work on needle. Lower foot. Take one stitch without changing width setting, bringing work to point C.

**Bar Tack**

Adjust stitch width selector for bar tacks and take at least six stitches. Stop at point D.

**Side Stitching**

Readjust stitch width selector for side stitching. Complete work to point E. Leave needle in fabric.

### Final Bar Tack

Adjust stitch width selector for bar tacks, and take at least six stitches ending at point F.

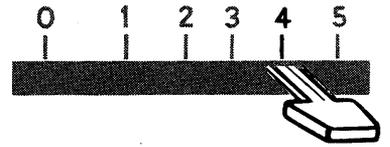

### Fastening Stitch

To secure stitching, move selector to 0 and take three stitches. Remove work, draw threads to underside, fasten, and trim. Cut opening for button with sharp scissors.



### Corded Buttonholes

Soft threads used for embroidery and crocheting make suitable filler cords for raised buttonholes. A fine pearl cotton (size No. 8) or silk buttonhole twist is generally used.

1. Unwind a sufficient amount of the filler cord to avoid tension or strain on the cord.
2. Lead the end of the cord through the raised eyelet on the special purpose foot. Draw the cord under and in back of the foot.
3. Proceed with stitching as for regular buttonholes.
4. Just before making the final bar tack, cut the filler cord close to the eyelet guide. Complete the bar tack and fasten buttonhole stitching as usual.
5. Carefully trim cord ends.

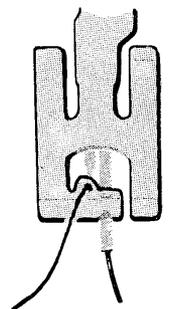
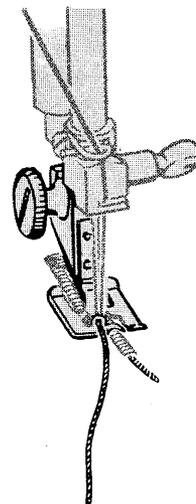
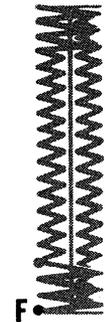

## ZIPPERS

At the notions counter in your Singer store, there are many different kinds of zippers. You will find one that will be just right for whatever you wish to sew. The zipper package will contain easy-to-follow instructions. And, if you use the zipper foot, you will find it easy to form an even line of stitching close to the zipper.

### Straight Stitch Zipper Insertion

Needle Position: **C**  
Stitch Width: **0**  
Stitch Length: To suit fabric  
Throat Plate: General Purpose or  
Straight Stitch  
Presser Foot: Zipper Foot

When the zipper is to the *right* of the needle:

1. Loosen the thumb screw at the back of the foot, and slide the foot to the *left* of the needle.
2. Check the position of the foot by lowering the needle into the side notch of the foot, making sure it clears the foot.
3. Lock the foot into position by tightening the thumb screw.

When the zipper is to the *left* of the needle, adjust the foot to the *right* of the needle in the same way.

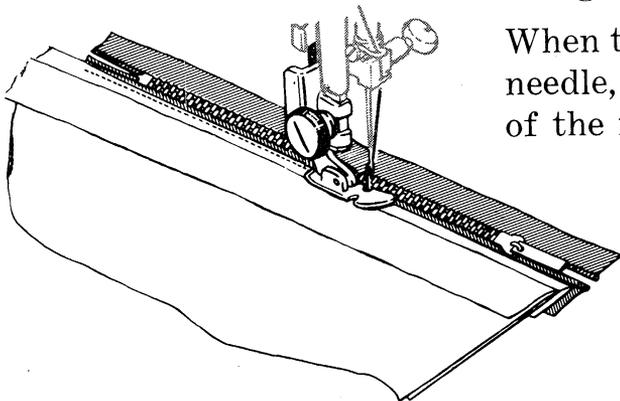

Zipper Insertion

# Finishing touches

## TOP STITCHING

A practical, simple way to accent the lines of a dress or coat is to place one or more rows of stitching along collars, lapels, facing edges, pockets, sleeves, etc. For a tailored look, use lines of straight stitching. For decorative interest, use a *Fashion* disc pattern. The seam guide will help you place the rows accurately.

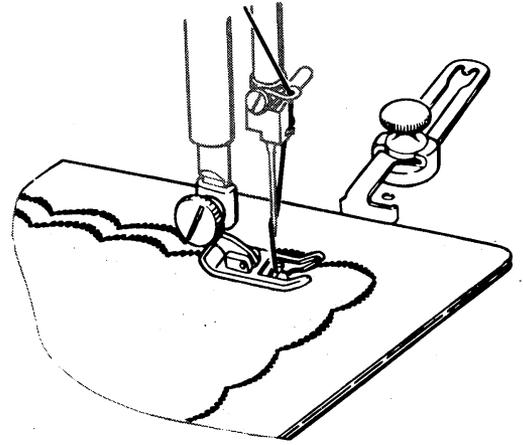

Top Stitching

## SHELL EDGING

*Fashion Disc:* 3  
*Needle Position:* C  
*Stitch Width:* To suit fabric  
*Stitch Length:* To suit fabric  
*Throat Plate:* General Purpose  
*Presser Foot:* General Purpose

On soft, fine fabrics, shell edging makes an attractive finish for narrow hems or bias folds.

Make a test on a sample of your fabric to find the right thread tension, stitch length, and stitch width.

1. Place folded hem (basted, if necessary) or bias fold under presser foot, with hem or fold toward the left.
2. Stitch slowly, guiding fabric so that the sideward stitches do not pierce the folded edge.

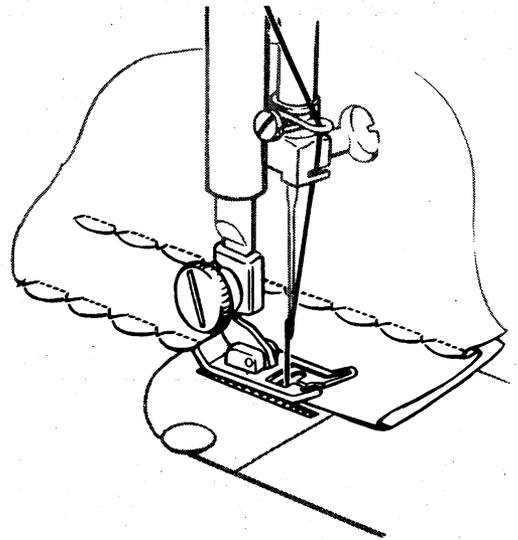

Shell Edging

Fashion Disc: **1** for zig-zag satin stitching. See page 25 for decorative stitches.

Needle Position: **C**

Stitch Width: To suit pattern

Stitch Length: **FINE (25 or above)**

Throat Plate: General Purpose

Presser Foot: Special Purpose

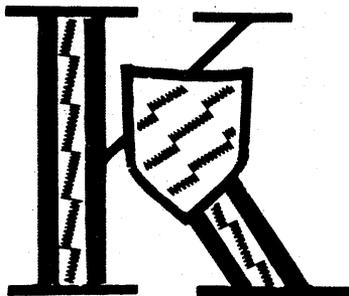

Monogram in Zig-Zag (1)  
and Banner Stitch (10)

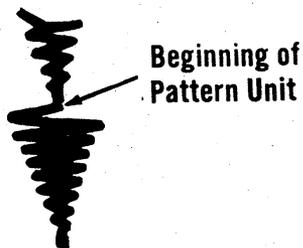

Arrowhead (5)

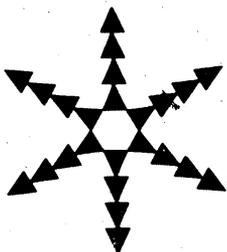

Arrowhead (5) in Star Motif

## MONOGRAMS AND MOTIFS

Many of the decorative stitch patterns can be used for monograms or motifs—for adding a personal touch to a blouse or collar, for example, or for initialing household linens. You can buy designs—or create them yourself.

### Stitching a Monogram or Motif

1. Make a sample first to determine suitability of stitch pattern and find the right stitch length and width, tension, and pressure.
2. Transfer the design (by tracing, usually) to right side of fabric.
3. If the fabric is soft or loosely woven, baste a backing of lawn or organdy onto the wrong side.
4. After stitching, trim the backing close to the stitching.

### Finding the Beginning of Pattern Unit

When using decorative stitch patterns in a motif, start stitching at the beginning of a pattern unit. To find the beginning:

1. On a scrap of material, stitch until you come to the end of a complete pattern unit; for example, the arrowhead. Now you are ready to start stitching at the beginning of the next unit.
2. Raise presser foot and remove scrap of fabric.
3. Position motif under needle, lower presser foot, and stitch.



## APPLIQUE

The stitch most commonly used in appliqueing is a plain zig-zag stitch (*Fashion* disc 1), closely spaced to form a satin stitch. The width of this stitch can be varied to accommodate fabrics of different weaves and textures. Many of the other *Fashion* disc patterns can also be used to applique with decorative stitching.

There are two methods of appliqueing: trimming after stitching and stitching after trimming. To decide which method you wish to use, make a sample to see which is the more appropriate for your fabric and design.

- Position the design
- Baste it to the fabric

### Method #1

*Fashion* Disc: Desired Pattern  
Needle Position: **C**  
Stitch Width: **2 to 4**  
Stitch Length: **FINE (25 or above)**  
Throat Plate: General Purpose  
Presser Foot: Special Purpose

1. Insert *Fashion* disc and set stitch width and stitch length at desired setting.
2. Stitch, outlining the design with applique stitching.
3. Trim any excess fabric on the outer edges of the stitching. Remove basting.

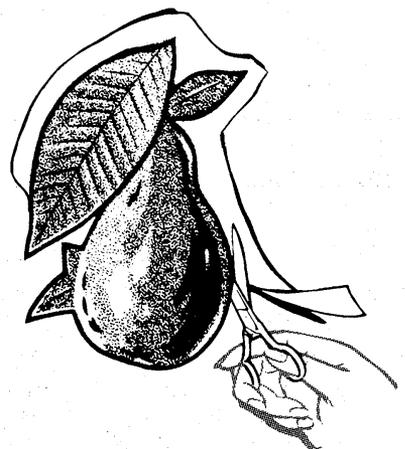

**Method #1 — Trimming after Stitching**

## Method #2

*Fashion Disc:* Desired Pattern  
*Needle Position:* C  
*Stitch Width:* 0, then 2 to 4  
*Stitch Length:* 15 to 20, then FINE  
*Throat Plate:* General Purpose  
*Presser Foot:* Special Purpose

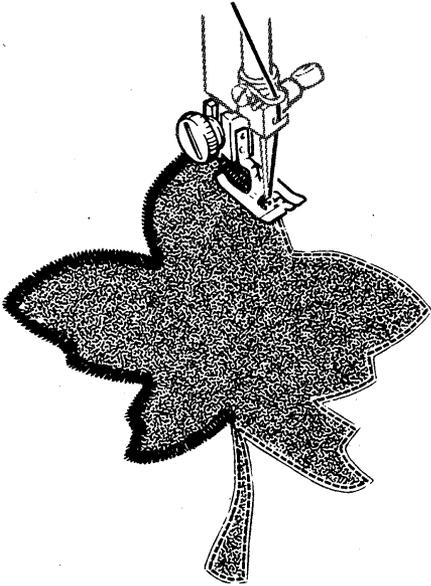

1. Outline the entire design with a short straight stitch.
2. Trim raw edges to the stitching.
3. Adjust stitch width selector to desired width setting for applique pattern. Set stitch length selector on FINE.
4. Stitch, following and covering the straight-stitch outline. This step will produce a smooth over-edged finish, with no raw edges to be trimmed. Remove basting.

### Method #2 Stitching after Trimming

### Corded Applique

Corded applique, which gives a raised, three-dimensional effect, is a particularly attractive finish for lace applique.

Follow either Method #1 or #2, described above, but first insert a cord of gimp, crochet thread, or buttonhole twist into the center eyelet on the special purpose presser foot. (See "Corded Buttonholes," page 49, for threading instructions.)

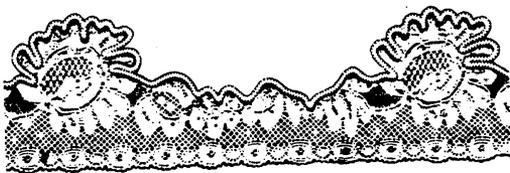

**Corded Lace Applique**

## FREE-MOTION STITCHING

In free-motion stitching, you sew without a presser foot and instead control fabric movement (and hence stitch length) yourself, by means of an embroidery hoop. Either a straight or a zig-zag stitch setting can be used. Because you can move the hoop in any direction—forward or backward, from side to side, and even diagonally—free-motion stitching is extremely useful for intricate embroidery designs. It is equally useful for darning.

If you are **embroidering**, you can vary the length of stitches simply by moving the hoop faster or slower. The faster you move it, the more open the stitches will be. A slow hoop movement will produce closely packed stitches. You can also vary the width of the stitches, from a hairline to the full width of whatever stitch width setting you have chosen, simply by moving the hoop.

If you move it sideways and stitch in a horizontal line, you will get a hairline; if you move it forward or backward and stitch in a vertical line, you will get full stitch width.

Thus you can produce a ribbon-like effect in script lettering. This takes practice, but you can achieve some lovely effects that look much like hand embroidery.

For **darning**, the embroidery hoop used in free-motion stitching enables you to hold the fabric taut—a real advantage when your fabric is lightweight or soft and thus is likely to pucker (see page 59).

### Preparing for Free-Motion Stitching

1. Get an embroidery hoop large enough to encompass the entire design or area to be darned.
2. Remove presser foot.
3. Attach feed cover plate (page 9).
4. Set stitch length selector at FINE.

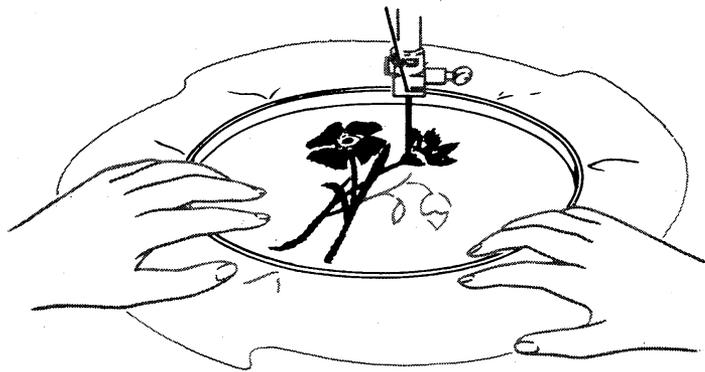

Free-Motion Stitching

## SCRIPT LETTERING

If you wish to embroider a whole name—on a child's dress or shirt, for example—you can do so by free-motion stitching.

Fashion Disc: 1  
Needle Position: C  
Stitch Width: 2 — 5  
Stitch Length: FINE (25 or above)  
Throat Plate: Feed Cover Plate  
Presser Foot: None

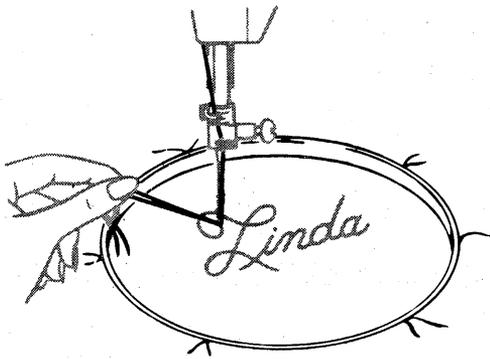

Script Lettering

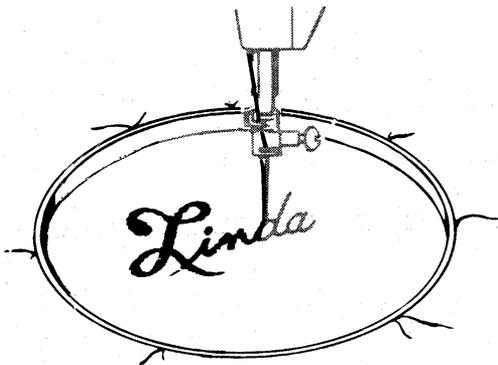

*When stitching is completed, replace feed cover plate with general purpose or straight stitch throat plate.*

1. Always make a sample first to find the right stitch settings and spacing.
2. Trace or mark lettering on right side of fabric. If the fabric is soft or loosely woven, add an underlay of crisp lawn or organdy.
3. Place work in embroidery hoop large enough to encompass the entire design. Be sure fabric is held taut.
4. Attach feed cover plate to machine.
5. Position work under needle and lower presser bar.
6. Hold needle thread loosely and turn hand wheel toward you to bring bobbin thread up through fabric at start of design. Hold both threads and lower the needle into the fabric.
7. Stitch, following outline of lettering. Maintain an even rate of speed so that stitches are uniformly spaced.

To produce a close satin stitch, move hoop slowly; to produce an open stitch, move hoop more rapidly. To shade the lettering, from wide to narrow stitching, turn the work slightly so that you will be moving it at an angle as you stitch.

# Keeping up appearances

## MENDING

Several of the zig-zag stitch patterns are just as useful for mending as they are for creative sewing. *Fashion* disc 2, which is a multi-stitch zig-zag, forms a firm, flexible bond for repairing tears and for reinforcing elastic. *Fashion* disc 1, which is plain zig-zag, is useful for making bar tacks to repair lingerie.

### Tears

1. Trim ragged edges.
2. Place underlay on the wrong side for reinforcement. Do not baste.
3. Stitch on the right side, bringing the edges of the tear together.
4. Shorten stitch length at ends and corners to give extra strength.
5. Trim underlay.

### Elastic

1. Fit elastic for desired snugness at waistline, allowing one inch for joining. Lap the ends and join with multi-stitch zig-zag.
2. Divide the elastic band and the garment waistline into quarters. Lap the elastic over the fabric and pin the two together at these intervals.
3. Take a few stitches to anchor elastic to fabric, then hold the elastic taut as you stitch.

### Bar Tacks

Use *Fashion* disc 1 at satin-stitch length to bar-tack garters, pockets, zippers, shoulder straps, etc.

*Fashion* Disc: 2  
Needle Position: C  
Stitch Width: 2—5  
Stitch Length: 12—20  
Throat Plate: General Purpose  
Presser Foot: General Purpose



**A Tear Mended with Multi-Stitch Zig-Zag**

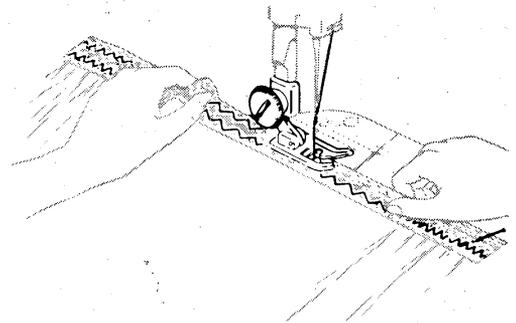

**Replacing Elastic with Multi-Stitch Zig-Zag**

## BLANKET BINDING

*Fashion Disc:* 2

*Needle Position:* C

*Stitch Width:* 5

*Stitch Length:* 15 — 20

*Throat Plate:* General Purpose

*Presser Foot:* General Purpose

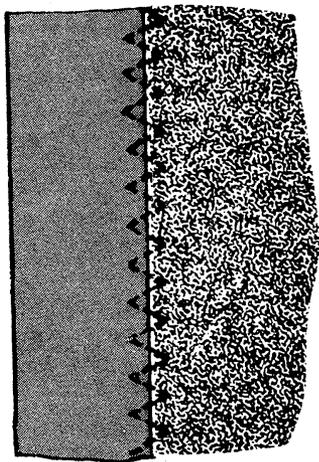

**Blanket Binding**

Often you can make an old blanket look almost new by replacing the binding.

1. Remove worn binding.
2. Baste new binding securely.
3. Reduce pressure and increase stitch length if necessary, so that blanket feeds freely.
4. Stitch and remove basting.

## DARNING

You may choose to darn either with or without an embroidery hoop. When greater control is needed, free-motion stitching with an embroidery hoop is usually best.

### Darning Without Embroidery Hoop

*Needle Position:* C

*Stitch Width:* 0

*Stitch Length:* 10 — 15

*Throat Plate:* Straight Stitch or  
General Purpose

*Presser Foot:* General Purpose

*Pressure:* D

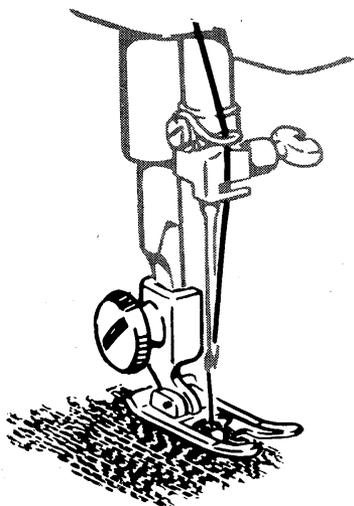

**Darning Without Embroidery Hoop**

1. If area to be darned is open, baste an underlay in place.
2. Place area to be darned under presser foot.

(continued on next page)

3. Lower presser foot and start stitching, alternately drawing fabric *gently* toward you and pulling it *gently* away from you.
4. Continue this forward and backward motion as you fill the area with parallel lines of stitching.
5. For additional strength, cover area with crosswise lines of stitching.

### Darning With Embroidery Hoop

Needle Position: **C**  
 Stitch Width: **0**  
 Stitch Length: **FINE (25 or above)**  
 Throat Plate: Feed Cover Plate  
 Presser Foot: None

1. Trim ragged edges from area to be darned and center worn section in embroidery hoop.
2. Attach feed cover plate to machine.
3. Position work under needle and lower presser bar.
4. Hold needle thread loosely with left hand, turn hand wheel over, and draw bobbin thread up through fabric. Hold both thread ends and lower needle into fabric.
5. Reinforce area to be darned with outline of running stitches.
6. Stitch across opening, moving hoop under needle at a slight angle from lower left to upper right. Keep lines of stitching closely spaced and even in length.
7. When opening is filled, turn work and cover area with crosswise lines of stitching.

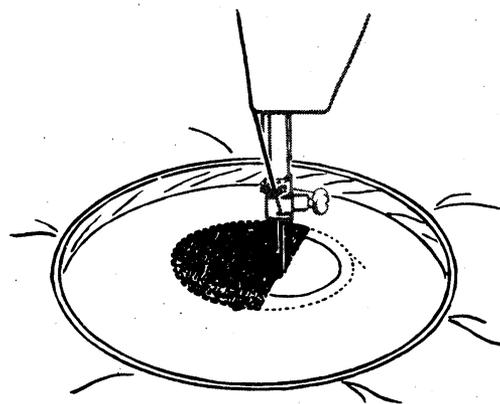
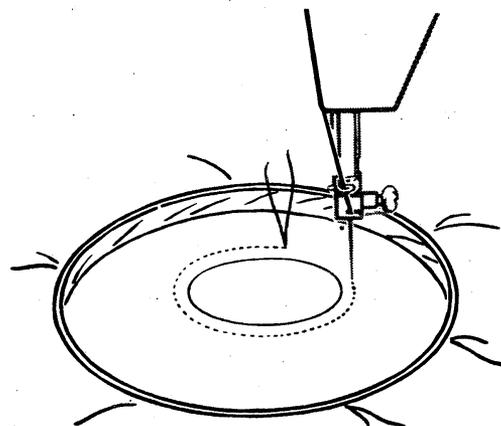

### Darning With Embroidery Hoop

*When stitching is completed, replace feed cover plate with general purpose or straight stitch throat plate.*

# Caring for your sewing machine

## CLEANING AND LUBRICATING THE MACHINE

How often you will need to clean and lubricate your machine will depend on how often you use it. The following general guidelines assume that you will be sewing several times a week. But if you use the machine more frequently, lubricate it more often than the guidelines suggest.

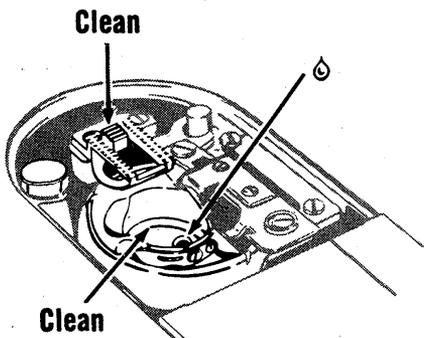
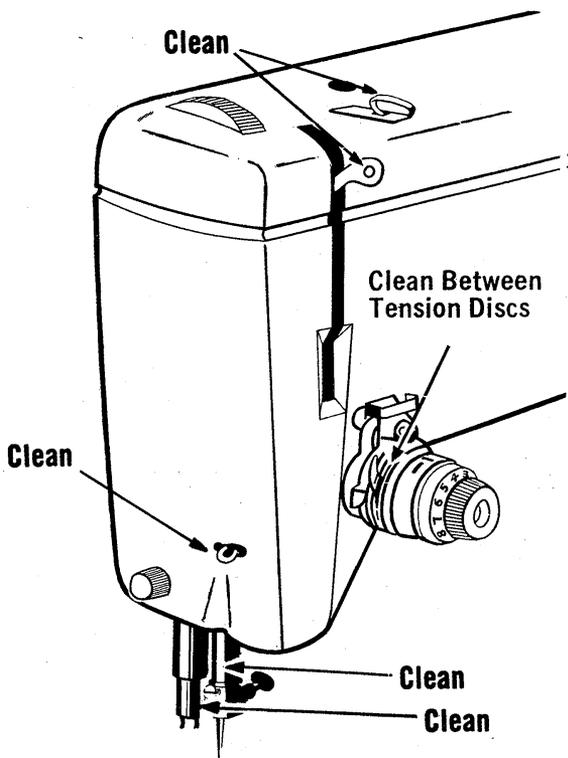

### Every Few Weeks

Remove lint or fluff from exposed parts with a soft cloth, and clean:

- Tension discs.
- Take-up lever and thread guides.
- Presser bar and needle bar.
- Bobbin case (If there is an excessive amount of lint in the area, remove the bobbin case for cleaning and oiling. See next page for instructions.)
- Machine arm and bed.

If necessary, dampen the cloth and use a mild soap to clean the machine surface.

Remove throat plate, as instructed on page 9, and with a lint brush, clean:

- Feed dog.
- Rotating hook (area under throat and slide plate).

After each cleaning, apply a drop (*but no more than a drop*) of SINGER\* oil to area indicated.



### Removing and Replacing Bobbin Case

- Raise presser foot.
- Turn hand wheel toward you until needle is in its highest position.
- Open slide plate with downward finger pressure. Draw plate toward you, opening it *all the way* to raise the throat plate clamping pin.
- Remove throat plate.

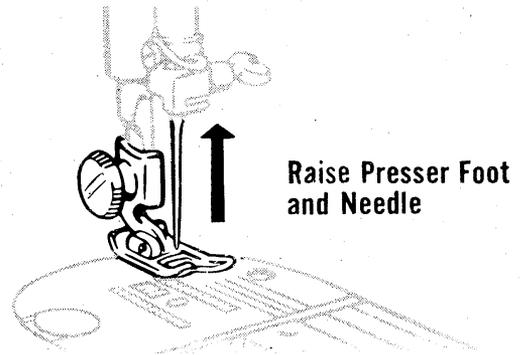

- Insert tension screwdriver under the lip of the bobbin case holder and lift up and to the right.

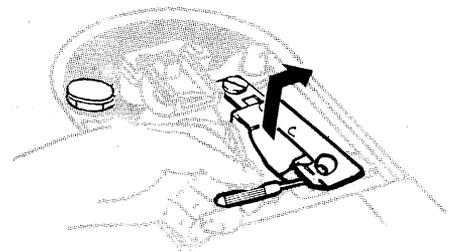

**Raise Bobbin Case Holder**

- Remove bobbin case.
- Clean thoroughly, removing all lint and fluff.
- Replace bobbin case so that groove under tension spring fits on hook raceway and fork of case straddles positioning stud under feed dog.
- Push holder to left until it snaps down into position.
- Replace throat plate.
- Close slide plate to lower throat plate clamping pin and secure throat plate.

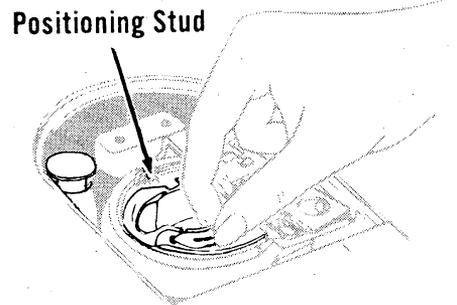

**Replace Bobbin Case**

## Every Few Months

Clean and oil area behind face plate.

- Remove face plate as instructed below.
- Apply a drop of oil to each spot shown.
- After oiling this area of the machine, sew a few lines of stitching on a scrap of fabric to remove excess oil.

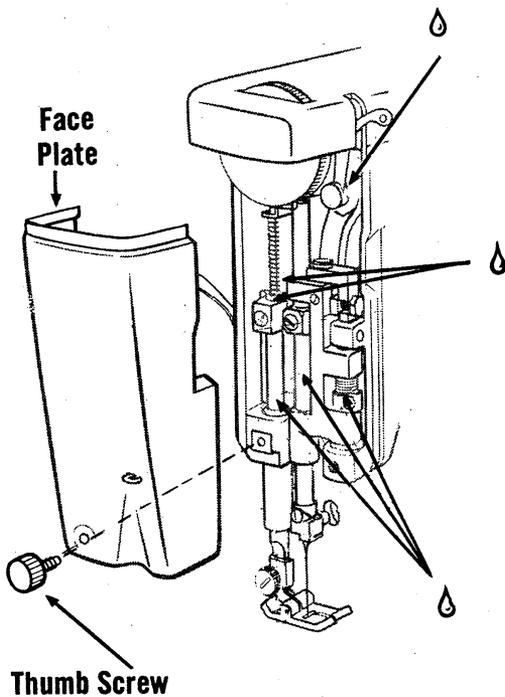

### Removing and Replacing the Face Plate

- Loosen and remove thumb screw and remove face plate by sliding it downward.
- Replace face plate by sliding it up so that top edge is engaged under edge of arm top cover.
- Align screw hole at lower edge of plate with screw hole in machine. Replace and tighten thumb screw.

## Every Year

Clean and lubricate driving mechanism at the top and bottom of the machine.

### Lubricating Top of Machine

- Disconnect machine from electrical supply.
- Loosen and remove screws A; lift off top cover.
- Apply a drop of oil to each place shown.
- Apply a small amount of SINGER\* lubricant to gears as shown. *Never apply oil to gears.*
- Replace top cover.

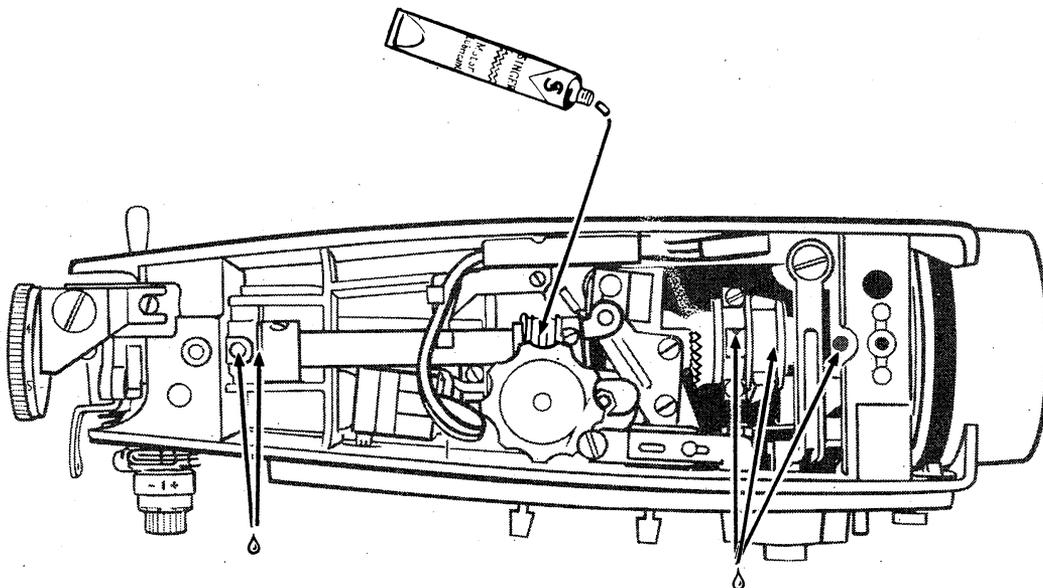
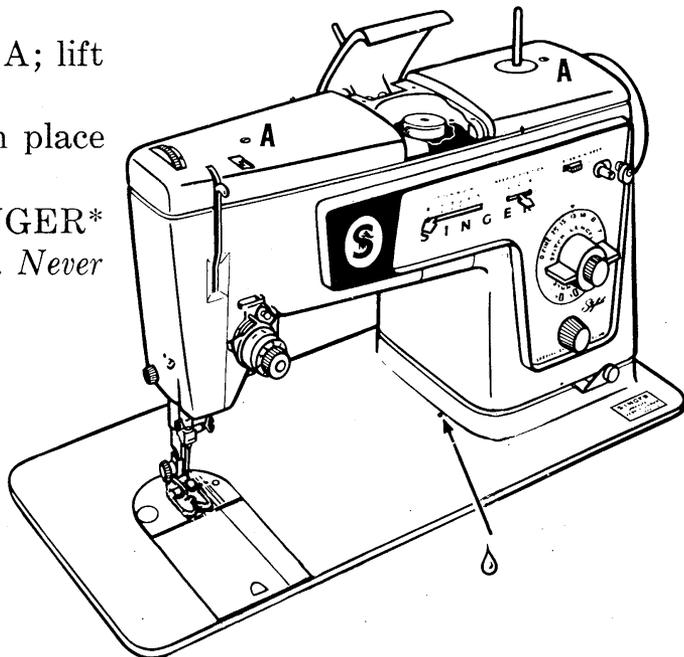

Lubricating Top of Machine

## Lubricating Bottom of Machine

- Disconnect machine plug from the electrical receptacle at right end of machine. If your machine is a portable, remove the carrying case base (as instructed below).
- Tilt machine back and remove retaining nut from threaded stud A, being careful not to lose felt washer, and remove cover from underside of machine.
- Oil each of the places indicated by arrows. Avoid getting oil on any part of motor or hook driving belt.
- Replace bottom cover, felt washer, and retaining nut. Tighten retaining nut with a screwdriver.

## Motor Requires No Lubrication

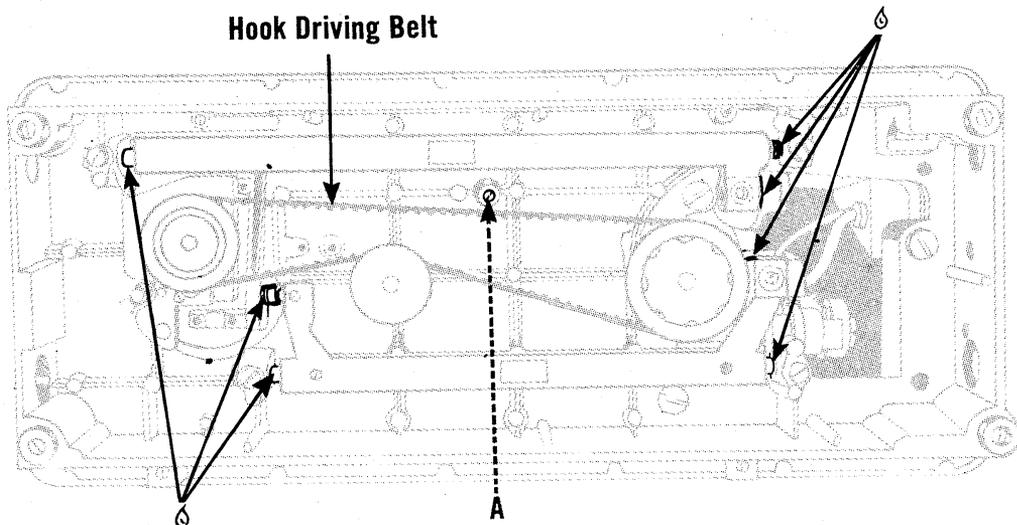

Lubricating Bottom of Machine

## Removing and Replacing Carrying Case Base

### Disconnect machine plug from electrical receptacle at right end of machine

- Turn machine so that back is toward you. Tilt machine back and loosen and remove the two screws at back of base and retaining nut in center.
- Set machine upright and lift up and out of base.
- Replace machine in base, after bottom cover has been attached, making sure machine bed is fully recessed.
- Turn machine so that back is toward you; tilt back and replace screws and retaining nut. Tighten screws with a screwdriver.

## Changing the Light Bulb

Be sure power and light switch is in "OFF" position.

### Removing the Bulb

With thumb and forefinger lower the light bracket. Do not attempt to unscrew bulb. Press it up into socket and at same time turn bulb over in direction shown to unlock bulb pin.

### Replacing the Bulb

Press new bulb into socket, with bulb pin entering slot of socket, and turn it over in direction shown to lock bulb in position. Release bracket, and entire assembly will snap back into recess.

### Replacing the Slide Plate

You will not have any occasion to remove the slide plate. However, if it should accidentally become disengaged from the machine, it is easily replaced.

- Raise presser foot and needle.
- Place slide plate in slideway with the front edge close to, but not covering, the retaining spring (as shown in illustration).
- With a screwdriver, lift each end of the spring into each of the side grooves on the underside of the slide plate.
- Draw the plate gently toward you and fully engage the spring.
- Close slide plate.

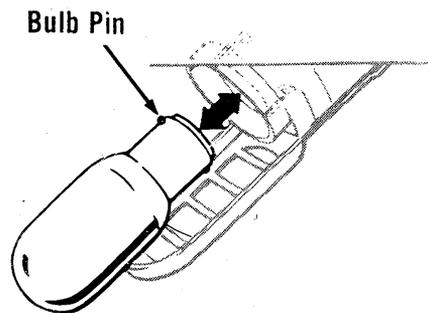
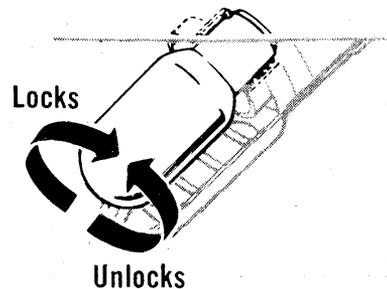

Changing the Light Bulb

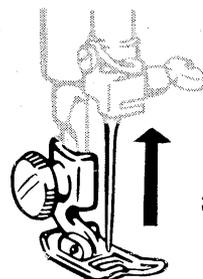

Raise Presser Foot and Needle

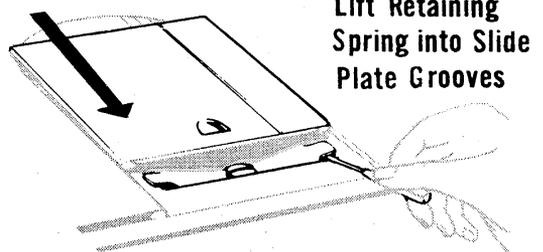

Lift Retaining Spring into Slide Plate Grooves

Replacing the Slide Plate

## **PERFORMANCE CHECK LIST**

### **If machine fails to start:**

- Are electrical plugs properly connected?
- Is power and light switch on?

### **If thread breaks:**

- Is machine properly threaded?
- Is needle the correct size for the thread and fabric you are using? Is a catalog 2020 (15 x 1) needle securely tightened in the needle clamp?
- Is thread free of slubs and knots?
- Is needle-thread tension too tight?
- Are thread guides, tension discs, and bobbin area lint-free?

### **If fabric fails to feed:**

- Is presser foot down?
- Is pressure adjusted properly for the weight and texture of your fabric?
- Is stitch length selector properly set?
- Is general purpose or straight stitch throat plate in place on machine?

### **Remember to:**

Refer to your instruction book. It was written to explain the most efficient way to operate and use this versatile new machine.

Keep your machine in good working condition by following the easy at-home-care steps outlined in the instruction book.

If you have any questions, please write to:  
Department of Sewing Education  
The Singer Company  
321 First Street, Elizabeth, N.J. 07207

## FASHION AIDS AVAILABLE FOR PURCHASE

Among the many *Fashion* aids that will fit your *Stylist* sewing machine are those described below. These are available at your local Singer store. These aids will increase the versatility of your machine and enable you to give your sewing that extra professional designer touch.

**The Edge Stitcher** No. 38685 . . . regulates the placement of straight stitching close to a fabric edge.

**The Gathering Foot** No. 161659 . . . ensures evenly spaced shirring with "locked-in" fullness.

**The Ruffler** No. 86742 . . . for gathered and pleated ruffles. Ruffles may be made separately or made and applied in one operation.

**The Quilting Foot** No. 35932 . . . excellent for the placement of stitching in block, floral, or scroll designs, and especially well adapted to stitching lightly padded materials.

**The Gauge Presser Foot** No. 121718 . . . single or multiple rows of straight stitching may be gauged evenly along lapel and facing edges, welt seams, or hems.

**The Professional\* Buttonholer** No. 102878 . . . works with your machine to sew six kinds of buttonholes plus eyelets in a wide variety of fabrics. You choose the style and the length. You can even adjust the width and cutting space, and make perfect buttonholes every time.

**Leather and Suede Needle**, catalog 2032 (15 x 2) . . . recommended whenever you stitch leather or suede. Its slim wedge point pierces skins cleanly to ensure a neat, uniform stitch. Use it in place of the catalog 2020 (15 x 1) needle. Available in sizes 11, 14, and 16.

### Additional *Fashion* Discs

The following additional *Fashion* discs are available for separate purchase at your local Singer store.

|                  |                 |                   |             |
|------------------|-----------------|-------------------|-------------|
| 4 Scallop        | 15 Long Oblique | 20 Curved Mending | 27 Fagoting |
| 7 Shell Edge     | 16 Shingle      | 22 Semaphore      | 28 Comb     |
| 11 Key           | 17 Pennant      | 24 Open Pyramid   | 29 Pavilion |
| 14 Zig-Zag Point | 18 Three Step   | 25 Spring         | 30 Platform |

## INDEX

|                                | Page      |                                | Page           |
|--------------------------------|-----------|--------------------------------|----------------|
| Accessories .....              | 6         | Power and Light Switch .....   | 3              |
| Applique .....                 | 53        | Presser Foot .....             | 2, 6, 7, 8     |
| Blanket Binding .....          | 58        | Changing .....                 | 8              |
| Blindstitch Guide .....        | 9, 41     | Presser Foot Lifter .....      | 3              |
| Blindstitch Hems .....         | 41        | Pressure Adjustment .....      | 3, 19          |
| Bobbin .....                   | 5, 10     | Pressure Regulating Dial ..... | 3, 19          |
| Winding .....                  | 10        | Principal Parts .....          | 2              |
| Bobbin Case .....              | 61        | Reverse-Stitch Push Button..   | 4, 18, 22, 24  |
| Threading .....                | 12        | Satin Stitching .....          | 28             |
| Button Foot .....              | 7, 42     | Script Lettering .....         | 56             |
| Buttonhole Foot .....          | 7, 44     | Seam Guide .....               | 9, 31          |
| Buttonholes .....              | 43        | Seams, Sewing .....            | 22             |
| Balancing Stitching .....      | 46        | Corded .....                   | 38             |
| Corded .....                   | 49        | Curved .....                   | 32             |
| Length .....                   | 43        | Finishes .....                 | 37             |
| Made with Built-in Four-Step   |           | Flat-Felled .....              | 36             |
| Buttonholer .....              | 4, 44     | Hairline .....                 | 34             |
| Made with Selector Settings    | 47        | Knit Fabric .....              | 35             |
| Buttons .....                  | 42        | Lingerie .....                 | 33             |
| Carrying Case Base             |           | Straight .....                 | 32             |
| Removing and Replacing .....   | 64        | Shell Edging .....             | 51             |
| Check List .....               | 66        | Slide Plate .....              | 3, 65          |
| Cleaning .....                 | 60        | Special Purpose Foot .....     | 7, 27, 47      |
| Darning .....                  | 58, 59    | Spool Pin .....                | 3              |
| Darts .....                    | 40        | For Twin-Needle Stitching..    | 30             |
| Electrical Speed Controller .. | 5         | Stitch Length .....            | 17, 18, 27, 28 |
| Embroidering .....             | 55        | Stitch Length Selector .....   | 4, 18, 22      |
| Fabric, Thread, Needle, and    |           | Stitch Width .....             | 15, 26         |
| Stitch Length Table .....      | 17        | Stitch Width Selector .....    | 4, 15, 26      |
| Face Plate                     |           | Stop-Motion Screw .....        | 5              |
| Removal and Replacement..      | 62        | Straight Stitch Foot .....     | 6              |
| <i>Fashion Aids</i> .....      | 67        | Straight Stitch Throat Plate.. | 6              |
| <i>Fashion Discs</i> .....     | 25        | Straight Stitching .....       | 15             |
| Available for Purchase .....   | 67        | Adjusting the Fabric .....     | 16             |
| Holder .....                   | 5, 26     | Needle Position .....          | 15             |
| Patterns .....                 | 25        | Take-up Lever .....            | 3              |
| Removal and Replacement..      | 26        | Tension Adjustment .....       | 3, 5           |
| Feed Cover Throat Plate .....  | 6         | For Straight Stitching .....   | 20             |
| Feed Dog .....                 | 3         | For Zig-Zag Stitching .....    | 27, 28         |
| Free-Motion Stitching .....    | 55        | Thread .....                   | 17             |
| General Purpose Foot .....     | 6, 27     | Thread Cutter .....            | 3              |
| General Purpose Throat Plate.. | 6, 27     | Threading the Machine .....    | 10             |
| Guiding and Supporting Fabric  | 23        | Throat Plate .....             | 2, 6           |
| Hand Wheel .....               | 3         | Changing .....                 | 9              |
| Hems, Blindstitch .....        | 41        | Top Stitching .....            | 51             |
| Light Bulb .....               | 65        | Twin-Needle Stitching .....    | 29             |
| Lubrication .....              | 62, 63    | Zig-Zag Stitching .....        | 25             |
| Mending .....                  | 57        | <i>Fashion Discs</i> .....     | 25             |
| Monograms .....                | 52        | Needle Position .....          | 26             |
| Motifs .....                   | 52        | General Purpose Foot .....     | 6, 27          |
| Needle .....                   | 16        | General Purpose Throat Plate   | 6, 27          |
| Replacement .....              | 16, 30    | Satin Stitching .....          | 28             |
| Threading .....                | 13        | Stitch Width .....             | 26             |
| Needle Position Selector ..... | 4, 15, 26 | Zipper Foot .....              | 7              |
| Pin Basting .....              | 31        | Zippers .....                  | 50             |



## GUARANTEE

WE GUARANTEE that each SINGER\* sewing machine has been carefully manufactured and is in perfect operating condition on delivery. When subject to normal family use and care, any parts requiring replacement at any time owing to defects in material or workmanship will be replaced without charge.

THIS GUARANTEE does not apply to parts requiring replacement owing to natural wear or to abuse or negligence of the user or in the event the machine is serviced by other than a SINGER representative or Approved Dealer or with parts other than those supplied by The Singer Company.

IN ADDITION to the above guarantee of parts, each machine will be inspected and adjusted whenever necessary without charge for labor for a period of one year from date of purchase.

THIS GUARANTEE is effective only with respect to the person making the purchase from The Singer Company or one of its Approved Dealers. The original Sales Agreement, or Cash Receipt, must be presented to obtain the benefits of the guarantee.

AGREEMENTS inconsistent with the foregoing shall be void and of no effect.

THE SINGER COMPANY



Portable Stereo by SINGER

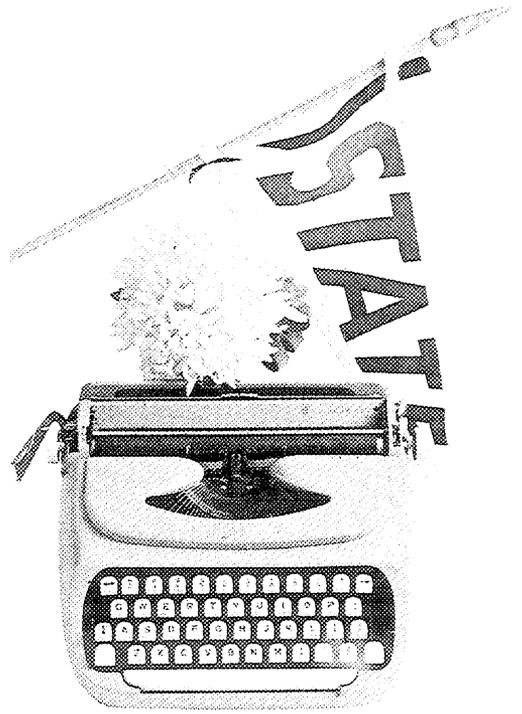

Portable Typewriter by SINGER

## Exciting Portables by SINGER

They go where you go! They play where you play! SINGER has designed a complete range of fine portable products expressly for our on-the-go generation. See the portables shown here and more at your Singer Store

*What's new for tomorrow is at SINGER today!\**



Portable TV by SINGER



Portable Phonograph by SINGER